

powered by
enervent[®]

Enervent[®] greenair

Ventilation unit with heat recovery

Planning, installation and operational instructions manual

Before installing and operating this unit,
please read this manual thoroughly, and retain it for future reference.

Electronic Climate Control

TABLE OF CONTENTS

OVERVIEW

TYPE MARKING	3
TYPE DESCRIPTION	3
FOREWORD	3
OPERATING PRINCIPLE	4
WARNING	4

INSTALLATION

DUCT HEAT INSULATION	4
EQUIPMENT	5
INSTALLATION	5

USER GUIDE

USER GUIDE	6
Starting the unit	
Supply and exhaust air calibration	
About ventilation	
Control panel	
CONTROL	8

MAINTENANCE

MAINTENANCE	9
BELT REPLACEMENT	11
SERVICE/ALARM INDICATION	12
TROUBLESHOOTING	12

TECHNICAL INFORMATION

TECHNICAL INFORMATION	13
DIMENSION DRAWINGS	15
HEAT RECOVERY EFFICIENCY	24
CHARACTERISTIC CURVES	27
OUTER WIRING	37
WIRING DIAGRAMS	39

DECLARATION OF CONFIRMITY	44
WARRANTY CONDITIONS	45



QUICK GUIDE TO THE VENTILATION UNIT

TYPE MARKING

Inside the ventilation unit is a type shield. Fill in the type shields data here to have it easily available when it is needed, e.g. when buying new filters.

This manual covers the following units:

- Enervent® greenair Plaza (eco) EC(E)
- Enervent® greenair Pingvin (eco) EC(E)
- Enervent® greenair Pingvin eco XL EC(E)
- Enervent® greenair Pandion (eco) EC(E)
- Enervent® greenair Pelican (eco) EC(E)
- Enervent® greenair Pegasos (eco) EC(E)
- Enervent® greenair Pegasos (eco) XL EC(E)
- Enervent® greenair LTR-3 (eco) EC(E)
- Enervent® greenair LTR-6 (eco) EC(E)
- Enervent® greenair LTR-7 (eco) EC(E)
- Enervent® greenair LTR-7 (eco) XL EC(E)

powered by enervent ®	ilmanvaihtolaite ventilation unit
TYYPPI/TYPER: SRJ.NRO/SERIAL NO: W / V / HZ / A:	
  ENERVENT OY KIPINÄTIE 1 06150 PORVOO TEL +358 (0)207 528800 FAX +358 (0) 207 528844	

TYPE DESCRIPTION

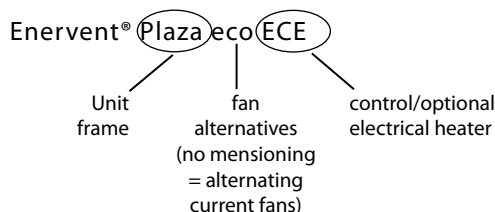

- eco Ventilation unit with direct current fans.
- EC Ventilation unit with ECC05 control, without after heater.
- ECE Ventilation unit with ECC05 control and electrical after heater.

FOREWORD

All greenair ventilation units are designed and manufactured for use all year round. In Finland the ventilation units have been installed in houses and other spaces for over 20 years and their popularity is increasing each year. Because of the knowledge and experience we have amassed during the years we can now manufacture more energy efficient and user friendly ventilation units. The Enervent® greenair unit series is the result of a long product development. All units in the series are very versatile and flexible.

A unit with basic functions can be installed, by your self, with the help of this manual, but certain special functions and the extra equipment should be connected by an electrician. We recommend that the installation is performed by a qualified ventilation engineer.

OPERATING PRINCIPLE

The ventilation units are based on regenerative heat recovery. This is achieved with a rotating heat exchanger through which incoming air and exhaust air flow in opposite directions. Aluminium foils within the heat exchanger transfer heat from the exhaust air to the supply air. A characteristic of the regenerative heat exchanger is its high rate of heat recovery (or efficiency).

The efficiency varies from 75 % to 85 %, depending on the proportion of supply air and exhaust air (the heat from the supply air fan is taken into account). Thanks to their high efficiency, the units save heating energy at the same time as they provide excellent indoor air quality; therefore they pay themselves back in a relatively short time.

WARNING

After opening the maintenance hatch wait two (2) minutes before starting the maintenance work! The fans rotate for a while even after the power is cut and the ECE-model electrical heater can be searing hot. There are no user-serviceable parts inside the control panel or inside the electrical cabinet, leave the service of these parts to a professional. It is important during troubleshooting not to turn on the power to the unit before being assured as to what the problem is.

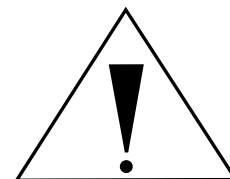

DUCT HEAT INSULATION

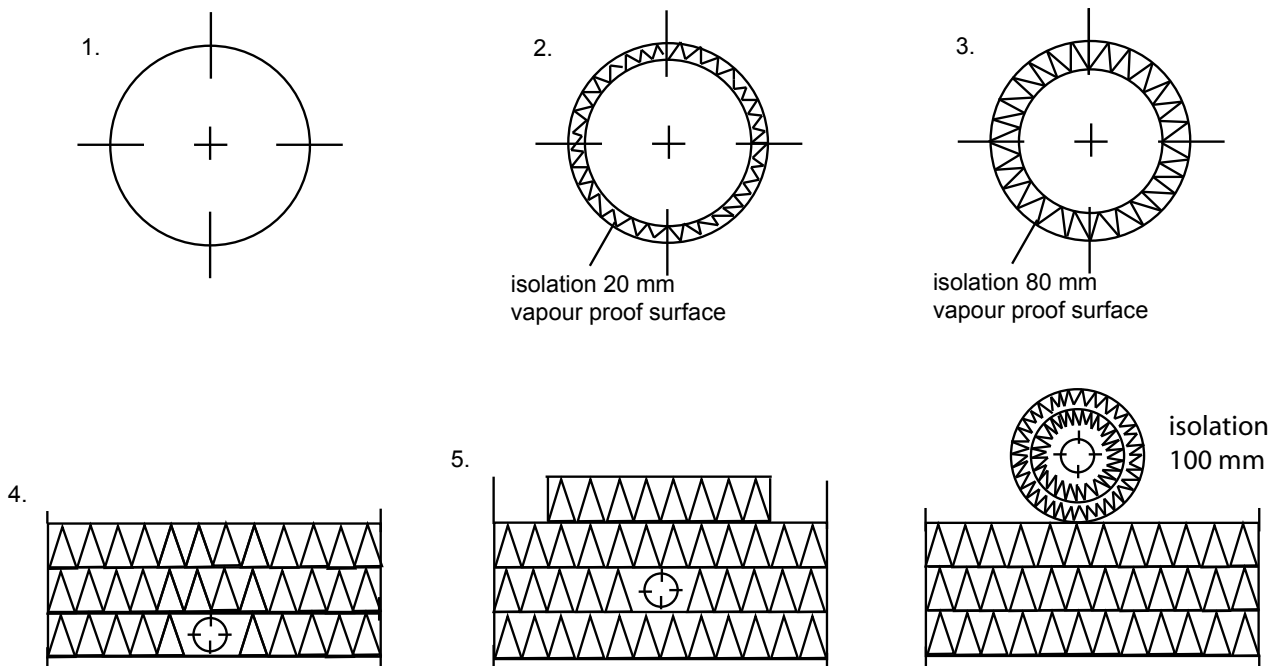

Examples of different insulation alternatives:

1. Exhaust air duct in warm spacing (indoors, no insulation).
2. Supply air duct between ventilation unit and terminal equipment.
3. Waste air and outside air duct in warm spacing (indoors).
4. Exhaust air duct in the ceiling insulation.
5. All ducts in a cold attic. Outside air and waste air ducts must not be assembled directly above the steam barrier. Both ducts require an insulation layer of 100 mm thick mineral wool.

EQUIPMENT

INCLUDED IN THE DELIVERY OF THE UNIT:

1. Enervent® greenair ventilation unit
2. Control panel *
3. Control panel cable RJ11, length 20 m (installation in a min 16 mm conduit) *

SEPARATELY SOLD EXTRA EQUIPMENT:

1. Control panel ECC-05(E), max. 1+4 panels can be connected to the unit.
2. Control panel cable RJ11 (length 20 m)
3. Push button for over-pressure control.
4. Class F7 filters.
5. Fine filter cassette F7 in duct casing.

* Does not concern Pingvin units. Pingvin units have a fixed control panel.

INSTALLATION

Install the Plaza, Pingvin, Pandion, Pelican and Pegasos units in a warm space (over +5°C) such as a utility room or a laundry but not a garage (separate fire area). The unit is installed hanging on the wall (Plaza, Pingvin, Pandion) or standing on the floor (Pandion, Pelican, Pegasos).

The LTR-3, LTR-6 and LTR-7 units can be installed in either a warm or cold space. The unit must be equipped with 100 mm extra insulation, if it is installed in a cold space. Suitable places for installation are for instance store rooms or on the attic. The unit should be placed on a plain surface on an elastic material that absorbs sound. For example, a 100 mm thick insulation plate is suitable as bedding.

If the unit is used to ventilate an area with a swimming pool, the unit must be drained. There is a drain outlet in the bottom of the unit (1/4" inner thread). At the time of delivery, the outlet is plugged.

PHASES OF INSTALLATION:

N.B.! To reduce the weight of the unit you can remove the heat recovery wheel before mounting the unit.

Plaza, Pingvin and Pandion on the wall

1. Mark and cut the holes into the ceiling.
2. Draw the ducts through the holes to the required height. The gaps between duct and steam barrier are then sealed, with for instance ventilation tape.
3. Pingvin and Pandion units: Install the rear attachment bracket directly to the wall at required height. An insulation board can be installed behind the unit to reduce the transfer of machine noise or vibration. Place the unit onto the lower bracket and fasten to the wall with the two top brackets. Attach the lower bracket with plate screws to the bottom of the unit. It is vital that the Pingvin unit is a little tilted backwards to ensure the function of the condense water drain on the unit. Should be checked with a level!
Other units: An insulation board can be installed behind the unit to reduce the transfer of machine noise or vibration. Lift the unit onto the wall and fasten it to the wall with the two top brackets.
4. Connect the ducts to the tubes on top of the unit. It is recommended that silencers be installed to the exhaust air and supply air ducts.
5. If the unit's condensation drain is to be used, connect a pipe between the drain outlet and the nearest floor drain or water trap of a sink. Connecting the unit directly into the sewage system is not allowed.

Pandion on the floor, Pelican and Pegasos

1. Install the unit on the floor or on a level built for the unit so that it stands on its own rubber pads. Leave at least a 10 mm opening between the back of the unit and the wall and a, at least, 15 mm opening to the sides. Also take in to account the space needed for drainage below the unit.
2. Make sure that there is at least 95 cm of free space in front of the unit's maintenance hatch and remember to leave the electric wirings easily accessible. The unit has a connecting plug. The connecting cable is located in one of the front corners above the smaller door. The length of the cable is 120 cm.
3. Connect the ducts to the unit with flexible connectors. Silencers are recommended to the supply air and exhaust air ducts.
4. If the unit's condensation drain is to be used, connect a pipe between the drain outlet and the nearest floor drain or water trap of a sink. Connecting the unit directly into the sewage system is not allowed.

LTR-3, LTR-6 and LTR-7

1. Place the unit on the insulation plate (i.e. 100 mm insulation covered with chipboard) in a storage room or in the attic on a custom made shelf. Take into consideration the possible need for a drain.
2. Check that there is enough free space on top (above the service hatch) (LTR-3 min. 50 cm, LTR-6 min 60 cm, LTR-7 min. 70 cm) and that the electrical inlets are accessible. Take into consideration that opening the hatches require a certain amount of space.
3. Connect the ducts to the spigots on the unit. It is recommended that silencers be installed to the exhaust air and supply air ducts.
4. If the unit's condensation drain is to be used, connect a pipe between the drain outlet and the nearest floor drain or water trap of a sink. Connecting the unit directly into the sewerage system is not allowed. If the unit is installed in a cold room the drain pipe must be insulated so that it doesn't freeze.

N.B! Detailed dimension drawings can be found in Chapter Technical information in the end of this manual.

USER GUIDE**STARTING THE UNIT**

Before the unit is ready for use the following installations should take place:

- Assemble the unit as stated in the chapter Instalation in this manual. Check with a water level to make sure that the unit is level, this is crucial for the drainage to work.
- Connect the drainage outlet with its own hose to an outflow supplied with a water lock (if the unit ventilates a space with swimming pool or if it is equipped with cooling).
- Instalel the duct and the silencers.
- Assemble the terminals on to the ducts.
- Provide the outside air duct with an outside air grating (N.B! the grating must not be provided with an insect net because it is difficult to keep clean!)
- Make the roof pass-through. We recommend the use of a factory made, insulated roof pass-through.
- Insulate the ducts as instructed.
- Provide the unit with the appropriate power supply.
- Connect the control panel to the unit with the RJ11 cable provided.

Open the units maintenance hatch with the key provided when all the above mentioned installation work is done. Check that the unit is clean on the inside, that there are no spare parts inside the unit and that the filters are clean. Close the maintenance hatch carefully.

SUPPLY AND EXHAUST AIR CALIBRATION

After the unit has been switched on its airflows must be calibrated to its planned values. When making the calibration all filters should be clean, all supply and exhaust air valves, the roof pass-through and the outside air grating should be in place. The outside air grating must not be provided with an insect net. The exhaust air flow should be ca. 5 - 10 % higher than the supply air flow. To achieve optimal values during calibration the airflows should be measured at each duct opening. A suitable measuring instrument would be a thermo anemometer. With the help of registered values the airflow can be regulated to achieve the projected values. A correctly calibrated ventilation unit is quiet and gives a good heat return and it also upholds a small under-pressure in the house. The under-pressure stops humidity from entering the walls and ceiling.

In EC- and ECE –models it is possible for the supply air fan to run one speed slower than the exhaust air fan. This is done by connecting pins -1 (TFC) on the main board.

To make it easier to adjust the air amount in eco EC and eco ECE-models, the speed (-20 %...+10 %) of the supply air fan can be adjusted with the trimmer on the main switch board. The regulation is proportional for the different speed positions. I.e. the regulation -10 % on speed setting 4 (100 %) means the exhaust air fan runs on 100 % and the supply air fan on 90 %, on speed setting 3 (80 %) it means the exhaust air fan runs on 80 % and the supply air fan on 72 %, on speed setting 2 (60 %) it means the exhaust air fan runs on 60 % and the supply air fan on 54 % and on speed setting 1 (40 %) it means the exhaust air fan runs on 40 % and the supply air fan on 36 %. When the exhaust and supply air fan run on the same speed the speeds are (1) 40 %, (2) 60 %, (3) 80 % and (4) 100 %. Each of the speeds can be reduced max 20 % with the switch board trimmer. There are totally 5 trimmers on the board.

ABOUT VENTILATION

The ventilation unit should never be switched off. It is important to always ventilate with a high enough effect! If the ventilation is insufficient the humidity indoors becomes too high and condensation can appear on, for instance, all the windows. A relative humidity of 40 - 45 % indoors is recommended (room temperature of 20 - 22°C). At these levels condensation will not form and the humidity will be at a healthy level. The humidity of a room can be measured with a hygrometer. When the humidity rises above 45 % one should increase the ventilation and when the humidity goes lower than 40 % one should lower the ventilation.

Check regularly that the filters are not dirty! During winter the exhaust filter become dirtier more quickly than the supply air filter. As a result of this the airflow lessens, which leads to lowered humidity indoors. This also leads to lower temperatures. Check the filters each month! At each filter inspection, check that the heat exchanger is functioning correctly, meaning check that it is rotating. Cover both the outside air intake and the waste air outtake if the unit is not to be used for a longer period. This way you stop moist from condensing on e.g. the fans electric motors.

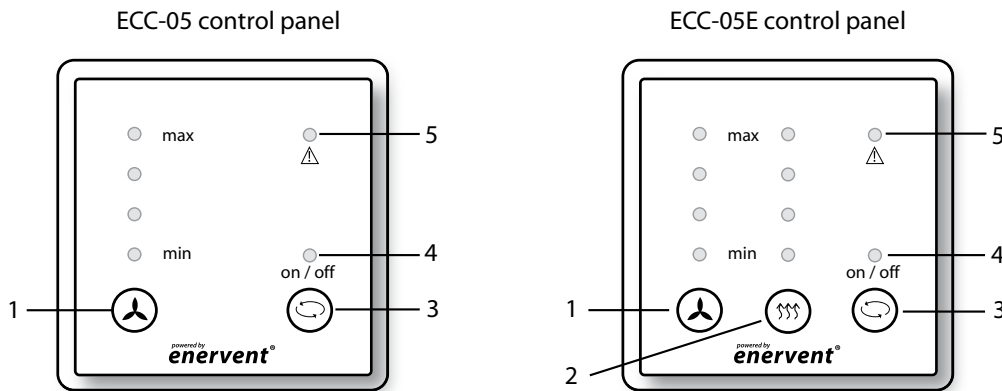

1. Fan speed button with 4 LED lights (4 fan speeds)
2. Button for supply air temperature with 4 LED lights (ECE –models)
3. Button for heat recovery
4. Heat recovery LED light
5. Service / Alarm LED light

CONTROL PANEL

Fan speed

There are 4 green LED lights for fan speed indication (minimum speed at bottom and maximum speed at top). Below the green LED's there is a button (1) for cycling through the fan speeds (see diagram on next page). The lights will turn on one at a time and they flash if in 'over pressure' mode.

Supply air heating

The ECE model's control panel has also a button (2) to turn on the electrical boost heater and to choose the supply air temperature. The four green LED lights show the supply air temperature as follows: +17°C, +19°C, +21°C, +23°C. The higher temperatures may be difficult to reach with fan speeds three and four.

Heat recovery

On the control panel there is a button and green LED light (3) for heat recovery. The heat recovery wheel is rotating and operational when the light is on. It is possible to turn off the heat recovery e.g. in summertime when the outside air temperature is the same as inside the house or when you want to take cool outside air into the house. If the heat recovery is turned on on a hot summer day it will work as a cooling recovery unit. It is possible to turn off the heat recovery unit only when the outside air temperature is above +15°C (setpoint can be adjusted between +10...+20°C from the main board potentiometer, see electrical connections). The heat recovery will start automatically when the outside air temperature drops below this setpoint.

Service / alarm

Service / alarm is indicated with a red LED light (4). It illuminates automatically every three months as a reminder to check the condition of the filters. The alarm is de-activated by switching off the electricity supply to the ventilation unit. The red LED will flash if supply air temperature drops below +5°C. It will also flash if the electrical heater's over heating protection has tripped, emergency stop is activated (if one is connected) or an external alarm is active (if connected).

CONTROL

EXTERNAL CONTROL

The units can be controlled externally with digital inputs i.e from a building automation or management system. The external commands will be updated to each of the control panels in the ventilation unit. The unit can be controlled either from the panels or externally and the last command will stay active.

Push button for over pressure

A push button can be wired to the ventilation unit's main board that will activate the over pressure function. During the over pressure cycle the supply air fan speed switches to speed 3 (eco-models speed 4) and the exhaust air fan speed switches to speed 1 (eco-models speed 2). The over pressure run time is set to 15 minutes. Over pressure can be switched off by turning it off or on the main electricity supply to the ventilation unit. **During the over pressure cycle, the fan speed LED light flashes.**

External speed control

It is possible to choose any fan speed, or to turn off fans, with external digital inputs. When the external stop is activated, the fans can be started again either from the control panel fan button (1) or with an external digital input.

Emergency stop

On the main board there are terminals (STOP) for external digital input for an emergency stop switch. The emergency stop will turn off the ventilation unit. It is restarted by de activating the emergency stop switch.

Cooling recovery

The rotating heat recovery wheel can be turned on and off (terminal LTOC) with an external temperature difference thermostat or from a building automation system. **During the cooling recovery cycle, the heat recovery LED light flashes.** Heat recovery cannot be stopped manually from the control panel during the cooling recovery cycle.

External alarm input

An external alarm input can be connected to the main board ALARM terminals i.e from a fire detection control or heating coil freezing protection. The unit can be restarted by de-activating the external alarm and by switching on and off main electricity supply to the ventilation unit.

EC(E) unit's main board (units with alternating current fans)

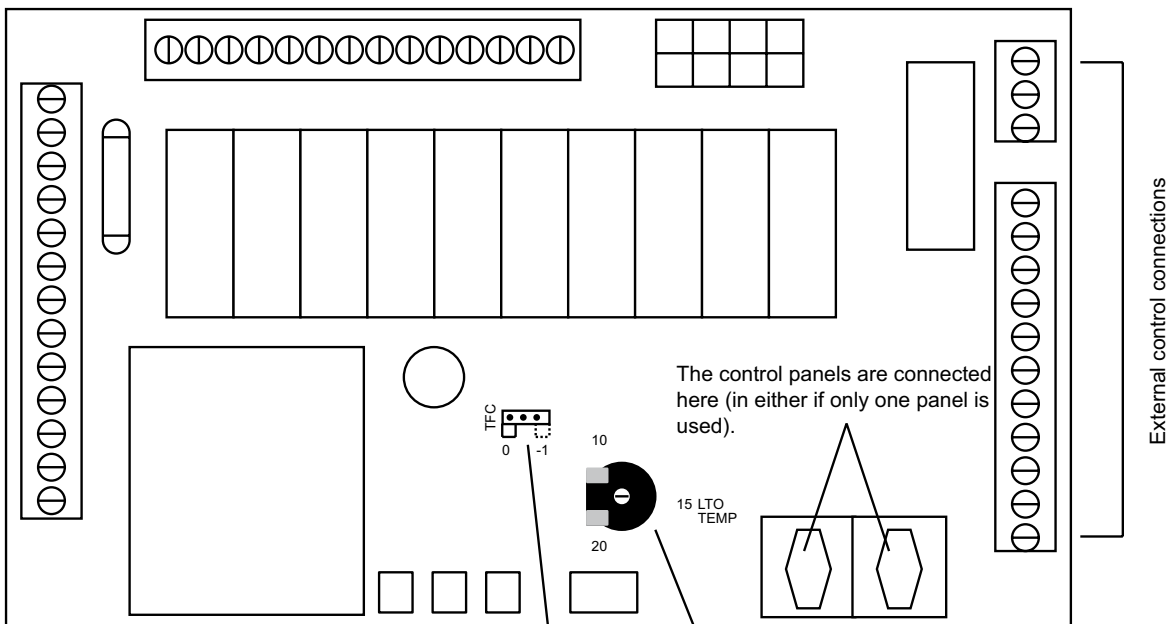

In EC- and ECE –models it is possible for the supply air fan to run one speed slower than the exhaust air fan. This is done by connecting pins -1 (TFC) on the main board.

It is possible to turn off the heat recovery unit only when the outside air temperature is above +15°C (setpoint can be adjusted between +10...+20°C from the main board potentiometer)

eco EC(E) units main board (units with direct current fans)

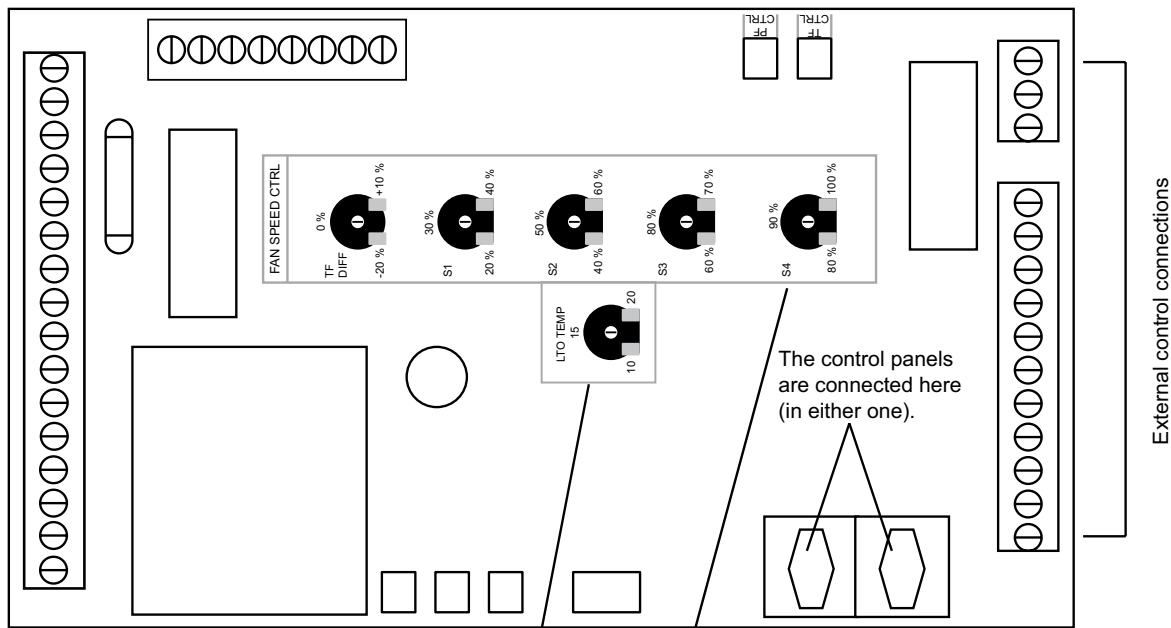

The heat recovery can be turned off only when the outside air temperature exceed +15°C (the value can be set on the potentiometer on the control card)

Trimmers for regulating the air amount. The regulation is proportional for the different speed positions. I.e. the regulation -10% on speed setting 4 (100%) means the exhaust air fan runs on 100% and the supply air fan on 90%. Also read the Ch. "Adjusting the proportion of supply air and exhaust air".

NOTE! MORE DETAILED CIRCUIT DIAGRAMS AT THE END OF THE MANUAL.

MAINTENANCE

The ventilation unit does not require any mechanical maintenance, only changing of the filters periodically and cleaning of the heat exchanger and fans (when needed). Cut the power supply to the unit before starting any service work (from the main switch or by removing the service hatch of the LTR-series units). Wait for two (2) minutes before starting the maintenance work! Although the unit's power supply is cut when the hatch is opened, the fans still rotate and the electrical coil in ECE-model is still hot for a while.

Cleaning the heat exchanger

When changing the filters, check if the heat exchanger is dirty. If cleaning is required, remove it from the unit and carefully wash through the air channels with a hand shower using a mild detergent, taking care not to get the motor wet. The heat exchanger can also be cleaned by blowing through the air channels using compressed air. Do not use a pressure washer and do not submerge the heat exchanger into water!! When restarting the unit after cleaning, check that the heat exchanger wheel can turn freely.

Cleaning the fans

When changing filters, also check the condition of the fans. If cleaning is required the fans can be removed from the unit and cleaned with a toothbrush or compressed air.

Changing of filters

The recommended time between filters changes is max. four (4) months for plain filters and max. six (6) months for bag filters. If class EU5 bagfilters are used the time between filter changes can be prolonged to one (1) year, by vacuuming the filters on the inside. Changing plain filters; Remove the filter cassettes from the device and loosen the filter fabric from the frame. Replace new filter fabric back into the frame. Replace the filter cassette back into the unit so that the support mesh faces towards the heat exchanger. Changing bag filters; Open the lock and remove the old filter and put in a new one. Remember to lock it afterwards.

Vacuum cleaning the inside of the device is recommended at this point. N.B! Make sure to close the service hatch carefully!

UNIT	STANDARD FILTERS	CHANGE RATE	ALTERNATIVE FILTERS	CHANGE RATE
Plaza	F7 cassette filter/ F5 bag filter	6 months	-	
Pingvin	F5 plane filter / F5 plane filter	4 months	F7 cassette filter in the supply air in addition to the F5 plane filter	6 months
Pingvin XL	F5 bag filter / F5 bag filter	6/12* months	F7 cassette filter in the supply air	6 months
Pandion	F5 bag filter / F5 bag filter	6/12* months	F7 bag filter in supply or/and exhaust air	6 months
Pelican	F5 bag filter / F5 bag filter	6/12* months	F7 bag filter in supply or/and exhaust air	6 months
Pegasos	F5 bag filter / F5 bag filter	6 months	F7 bag filter in supply or/and exhaust air	6 months
LTR-3	F5 plane filter / F5 plane filter	4 months	F5 or F7 bag filter in supply or/and exhaust air	6/12* months
LTR-6	F5 bag filter / F5 bag filter	6/12* months	F7 bag filter in supply or/and exhaust air	6 months
LTR-7	F5 bag filter / F5 bag filter	6/12* months	F7 bag filter in supply or/and exhaust air	6 months

* The utilization time can be prolonged by vacuuming the filter bags on the inside. NOTE! The F7 filters break if they are vacuumed.

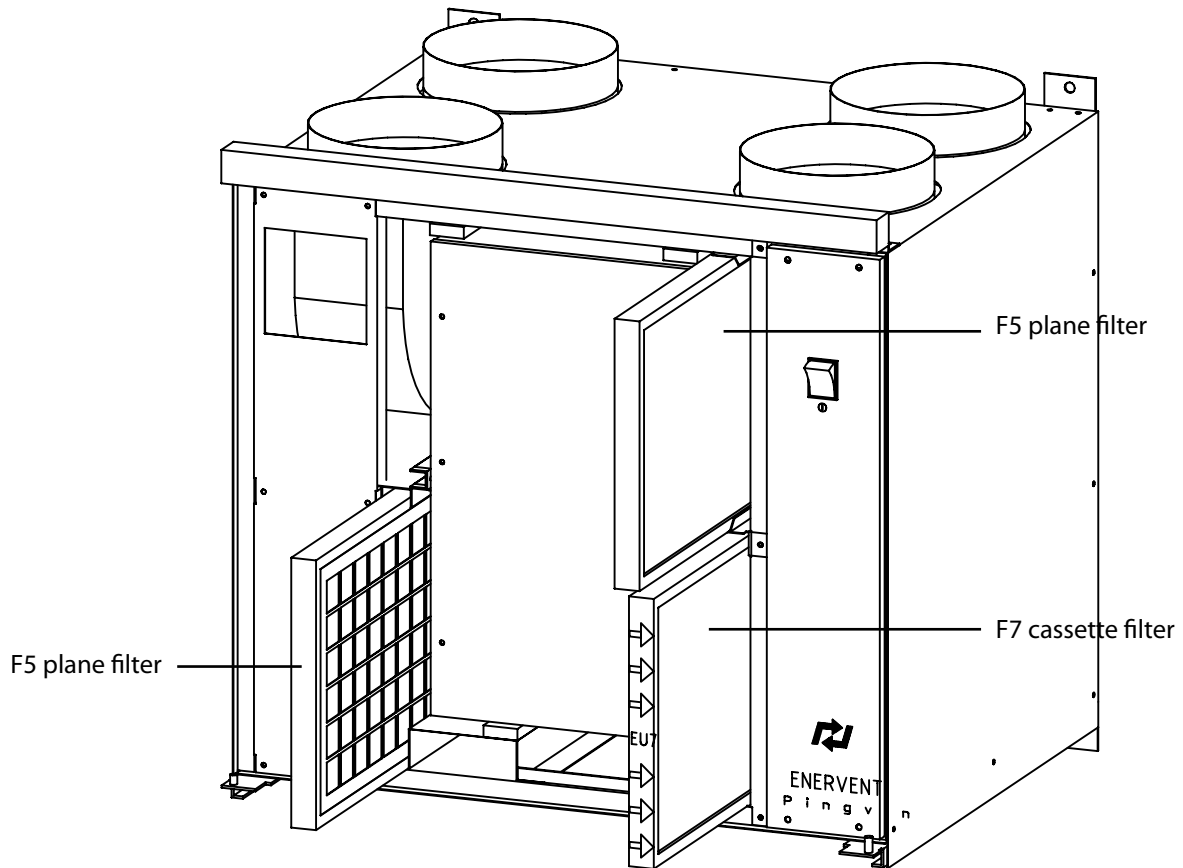

Usually there is one supply air filter and one exhaust air filter in a ventilation unit. The Pingvin ventilation unit is an exception. In the picture above it is shown how the filters are placed when the unit is equipped with F7 cassette filter in the supply air.

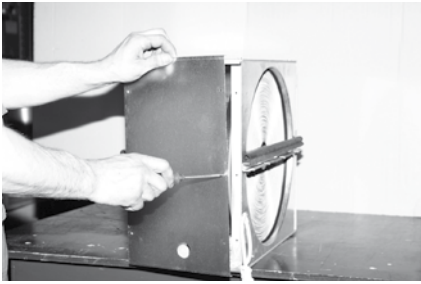

pic 1

Turn of the ventilation unit by switching off the main power supply, removing the fuse or disconnecting the wall plug.

Open the maintenance hatch.

Unplug the heat exchanger.
Pull out the heat exchanger from the ventilation unit.



pic 2

Remove the lid by detaching the screws (pic 1).

Turn the heat exchanger on to its side so that the axle is in a vertical position. Remove the sealing strip (pic 2).

Detach the hexagonal screw and the screws in the u-beam.

Remove the u-beam.

Remove the old belt.



pic 3

Remove any possible dirt from the rotors surface and carefully place the new belt inside the heat exchanger through outer shell and the gasket (pic 3 and 4).

Carefully pull the belt past the gasket and rotate the rotor at the same time. Assemble the u-beam.

Attach the beams screws and the hexagonal screw of the axle.

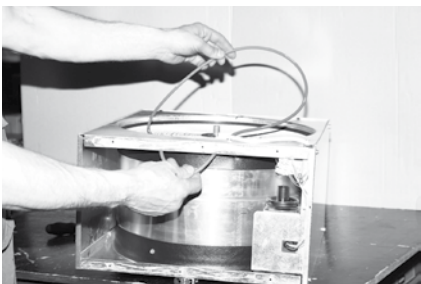

pic 4

Put the belt on to the belt wheel and rotate the rotor away from the motor a couple of times (pic 5).

Clean the inside of the heat exchanger.

Close the lid.

Re-assemble the heat exchanger in to the ventilation unit and plug it in.

Turn on the ventilation unit and check that the heat exchanger is rotating.

Close the maintenance hatch.

NOTE! A spare belt is delivered with the ventilation unit, it is attached to the inside of the heat exchanger.

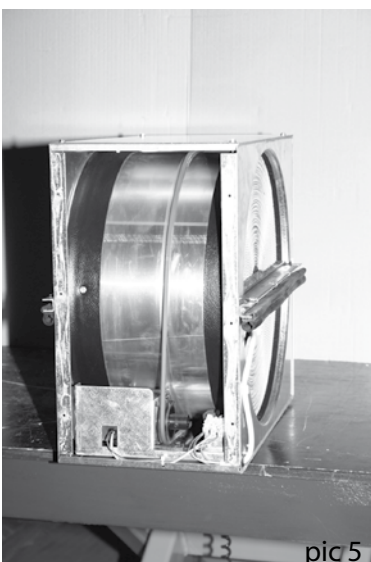

pic 5

SERVICE / ALARM INDICATION

 RED LED LIGHT		
LED:	VENTILATION UNIT:	SWITCH OFF THE ALARM:
LED is on: - filter change reminder	works normally	ventilation unit main power switch
LED is flashing: - supply air temperature after HRW is below +5°C - electrical heater overheating protection went off - external emergency stop is on - external alarm is on	exhaust air fan is on speed 1, supply air fan and HRW are off exhaust air fan is on speed 1, supply air fan and HRW are off ventilation unit is off ventilation unit is off	automatically, when temperature is above +5°C emergency stop switch fix the external alarm / unit power switch

TROUBLE SHOOTING

SUPPLY AIR TOO COLD

Reason	Action
The heat exchanger switch is tuned off.	Switch it on.
Belt of the heat exchanger broken.	Replace the belt.
Belt greasy, causing slippage.	Contact a service representative.
The exhaust fan has stopped.	Contact a service representative.
The exhaust air filter is blocked.	Change the filters.
Exhaust air valve settings incorrect.	Contact a service representative.
Heat insulation of ducts inadequate.	Check the insulation thickness of the supply and exhaust air ducts and add insulation if needed.
The after heater over heating protection has gone off (ECE-models).	Check what the reason to the problem is and reset the over heating protection.

REDUCED AIR FLOW

Reason	Action
Filters are blocked.	Change the filters.
Too small a fan speed is selected.	Select higher speed.
Blockage in the fresh air grille.	Clean the outer grille.
Fan wings dirty.	Clean the fans.

INCREASED OPERATING SOUND LEVEL

Reason	Action
Filters blocked.	Change the filters.
Outer grilles are blocked.	Clean the outer grille .
Fan bearings faulty.	Change bearings / contact service.
Fan wings dirty.	Clean the fans.
Problem with gear/motor of the heat exchanger.	Contact a service representative.

TECHNICAL INFORMATION

VENTILATION UNIT:	LTR-3-85	LTR-3-120	LTR-6	LTR-7	LTR-7-XL
Length	840 mm	840 mm	1 190 mm	1 510 mm	1 510 mm
Width	470 mm	470 mm	660 mm	707 mm	707 mm
Height	500 mm	500 mm	660 mm	720 mm	720 mm
Weight	52 kg	52 kg	96 kg	130 kg	130 kg
Duct connections	Ø 160 mm	Ø 160 mm	Ø 200 mm	Ø 250 mm	Ø 250 mm
AC fans supply/exhaust	130 W, 0,57 A	185 W, 0,80 A	300 W, 1,40 A	-	450 W, 3,20 A
DC fans supply/exhaust	-	119 W, 0,9 A	170 W, 1,22 A	520 W, 3,3 A	545 W, 3,5 A
Electrical after heater efficiency	500 W	500 W	2 000 W	4 000 W	4 000 W
Current	230 V~, 50 Hz	230 V~, 50 Hz	EC: 230 V~, 50 Hz	EC: 230 V~, 50 Hz	EC: 230 V~, 50 Hz
Fuse	10 A quick	10 A quick	10 A quick	10 A quick	10 A quick
Current			ECE: 230 V~, 50 Hz	ECE: 400 V 3~, 50 Hz	ECE: 400 V 3~, 50 Hz
Fuse			16 A quick	3x16 A quick	3x16 A quick
Main board glass pipe fuse 5x20 mm	F1 T1,6 A	F1 T1,6 A	F1 T3,15 A	F1 T5 A	F1 T8 A
Heat exchanger motor rating	8 W, 0.035 A	8 W, 0.035 A	8 W, 0.035 A	8 W, 0.035 A	8 W, 0.035 A

VENTILATION UNIT:	PLAZA	PINGVIN 85	PINGVIN 120	PINGVIN XL
Width	598 mm	580 mm	580 mm	780 mm
Depth	320 mm	500 mm	500 mm	555 mm
Hight	630 mm	540 mm	540 mm	540 mm
Weight	45 kg	50 kg	50 kg	63 kg
Duct connections	Ø 125 mm	Ø 160 mm	Ø 160 mm	Ø 160 mm
AC fans supply/exhaust	-	130 W 0,57 A	185 W 0,80 A	-
DC fans supply/exhaust	119 W 0,9 A	-	119 W 0,9 A	230 W
Electrical after heater	400 W	400 W	400 W	400 W
Current	230 V~, 50 Hz	230 V~, 50 Hz	230 V~, 50 Hz	230 V~, 50 Hz
Fuse	10 A quick	10 A quick	10 A quick	10 A quick
Current				
Fuse				
Main board glas pipe fuse 5x20 mm	F1 T1,6 A	F1 T1,6 A	F1 T1,6 A	F1 T1,6 A
Heat exchanger motor rating	8 W, 0.035 A	8 W, 0.035 A	8 W, 0.035 A	8 W, 0.035 A

VENTILATION UNIT:	PANDION	PELICAN	PEGASOS	PEGASOS XL
Width	785 mm	998 mm	1 250 mm	1 250 mm
Depth	543 mm	590 mm	677 mm	677 mm
Hight	895 mm	1 270 mm	1 400 mm	1 400 mm
Weight	90 kg	125 kg	203 kg	203 kg
Duct connections	Ø 160 mm	Ø 200 mm	Ø 250 mm	Ø 250 mm
AC fans supply/exhaust	-	300 W 1,40 A	-	810 W, 3,85 A
DC fans supply/exhaust	200 W	170 W 1,22 A	520 W 3,3 A	545 W, 3,5 A
Electrical after heater	800 W	2 000 W	4 000 W	4 000 W
Current	230 V~, 50 Hz	EC: 230 V~, 50 Hz	EC: 230 V~, 50 Hz	EC: 230 V~, 50 Hz
Fuse	10 A quick	10 A quick	10 A quick	10 A quick
Current		ECE: 230 V~, 50 Hz	ECE: 400 V 3~, 50 Hz	ECE: 400 V 3~, 50 Hz
Fuse		16 A quick	3x16 A quick	3x16 A quick
Main board glas pipe fuse 5x20 mm	F1 T3,15 A	F1 T3,15 A	F1 T5 A	F1 T8 A
Heat exchanger motor rating	8 W, 0.035 A	8 W, 0.035 A	8 W, 0.035 A	8 W, 0.035 A

Enervent® greenair PLAZA

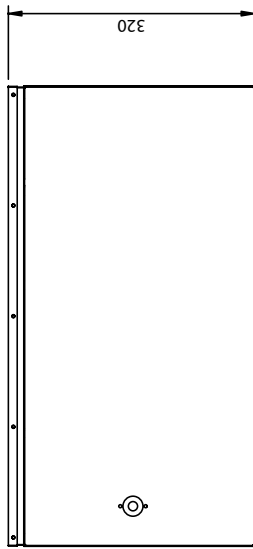
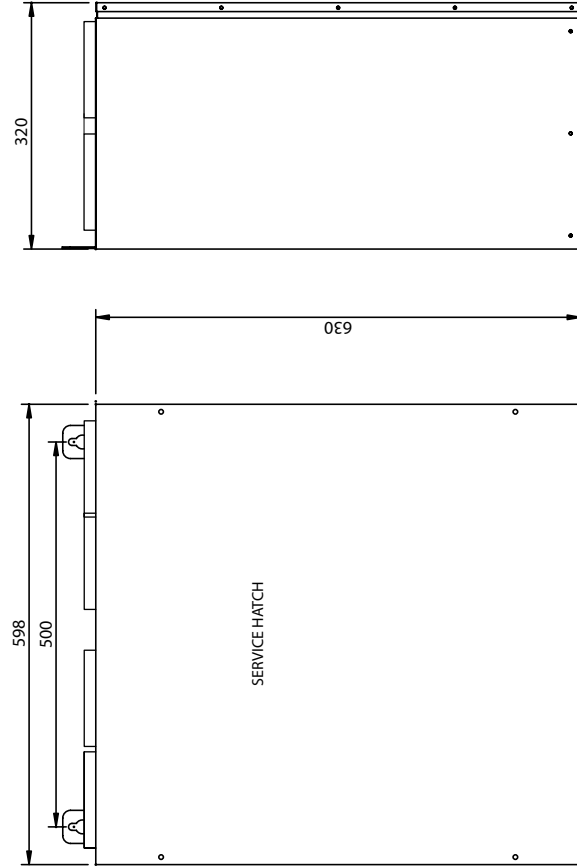
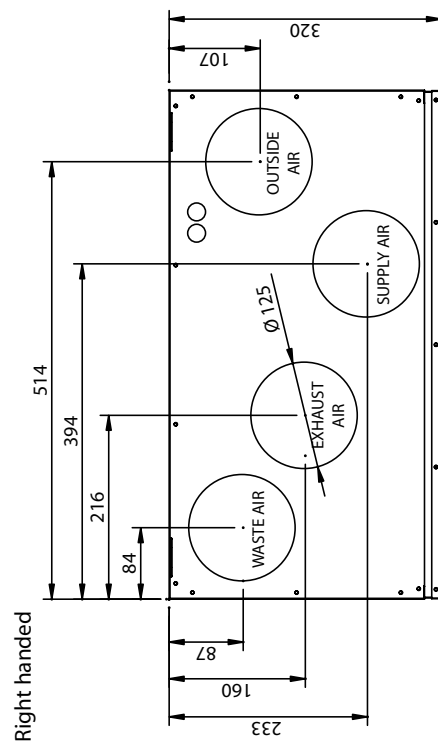
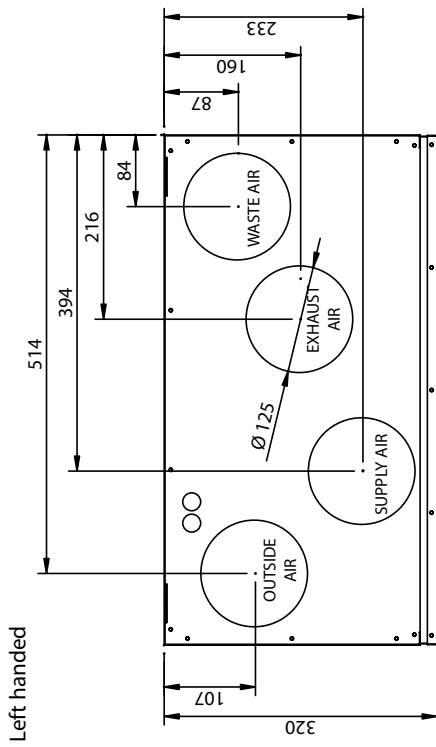

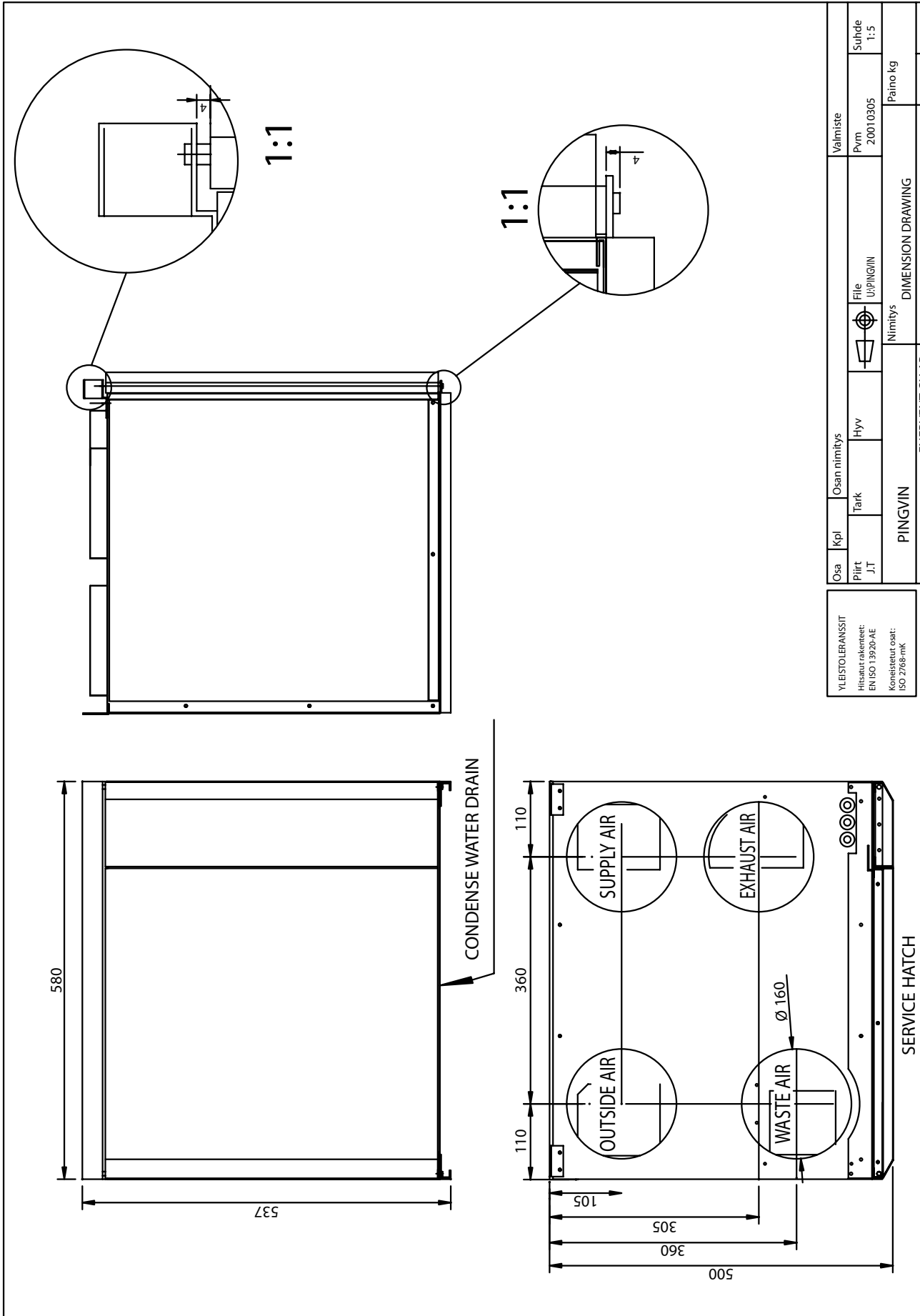

YLEISTÖLERÄNSSIT Hicisatut ralemeest: EN ISO 13929:AE Koneistetut oast: ISO 2768-mk		Osa		Kpl	Osan nimitys	Vaimiste		Suhde		
20020528		Piirt	J/T	Tark	Hyv	File	U:SPINGVIN	Pvm	20010305	1:5
20020528		PINGVIN				Nimitys		Paino kg		
20020528		PINGVIN				DIMENSION DRAWING		Muutos		
20020528		PINGVIN				Pir no		Lehti		
20020528		PINGVIN				PINGVIN K00 001		1		

powered by **enervent**
ENERVENT OY AB
P.O. Box 100, 01501 Vammala, Finland
Internet E-mail: enervent@enervent.fi

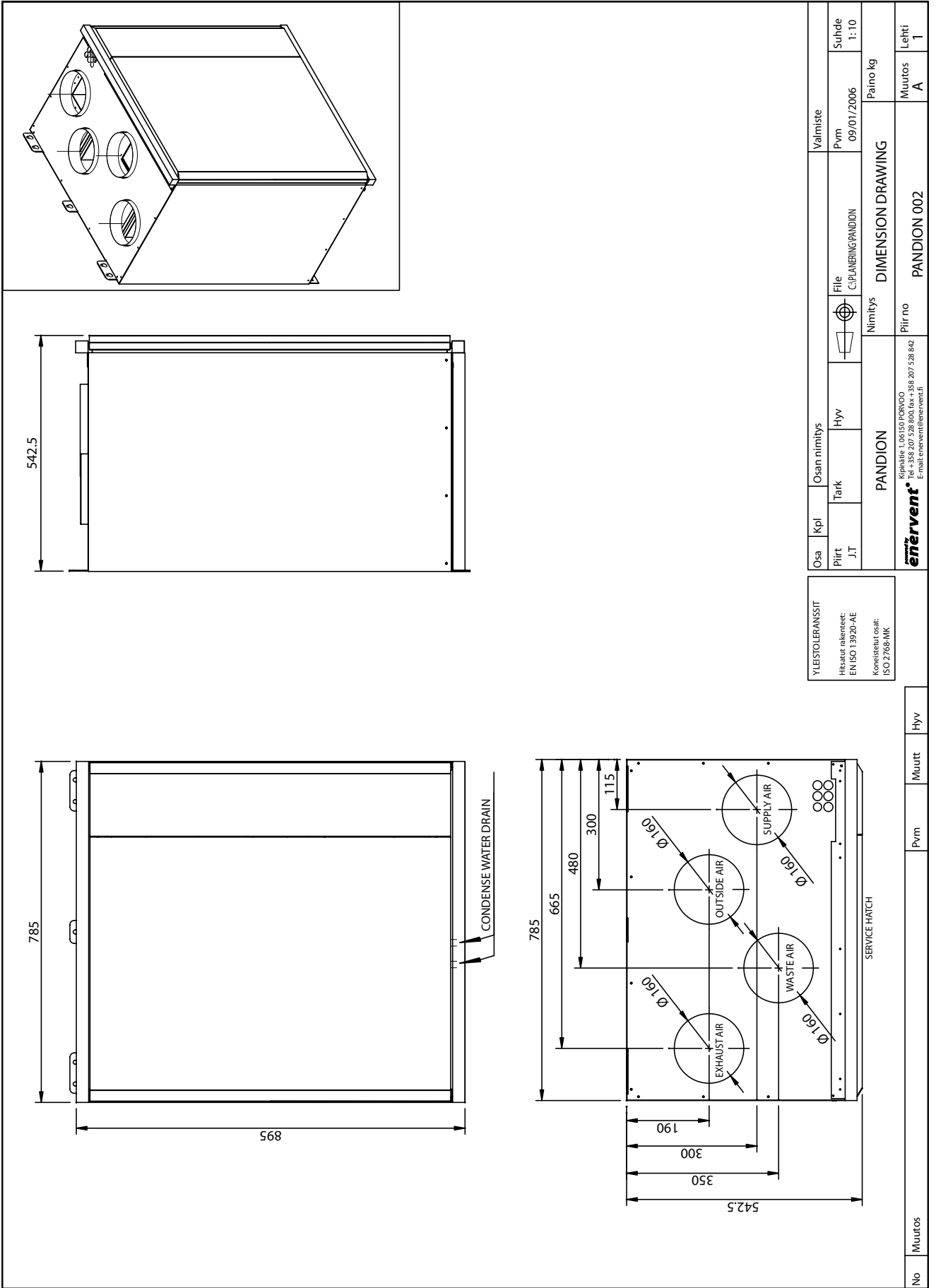

YLEISTOLERANSSIT
 Hitsatur olennett:
 EN ISO 13920-AE
 Koneisteur osat:
 ISO 2768-MK

Osa	Kpl	Osan nimitys	Valmistaja	Paino kg
Piirt J.T		Tark Hyv	Pvm 09/01/2006	Suhde 1: 10
PANDION			Nimitys DIMENSION DRAWING	Lehti 1
Kipulaite 1,06150 PORVOO Tel +358 207 528 800, fax +358 207 528 842 E-mail: enervent@enervent.fi			Piir no PANDION.002	Muutos A
enervent®				

No	Muutos	Pvm	Muutt	Hyv
----	--------	-----	-------	-----

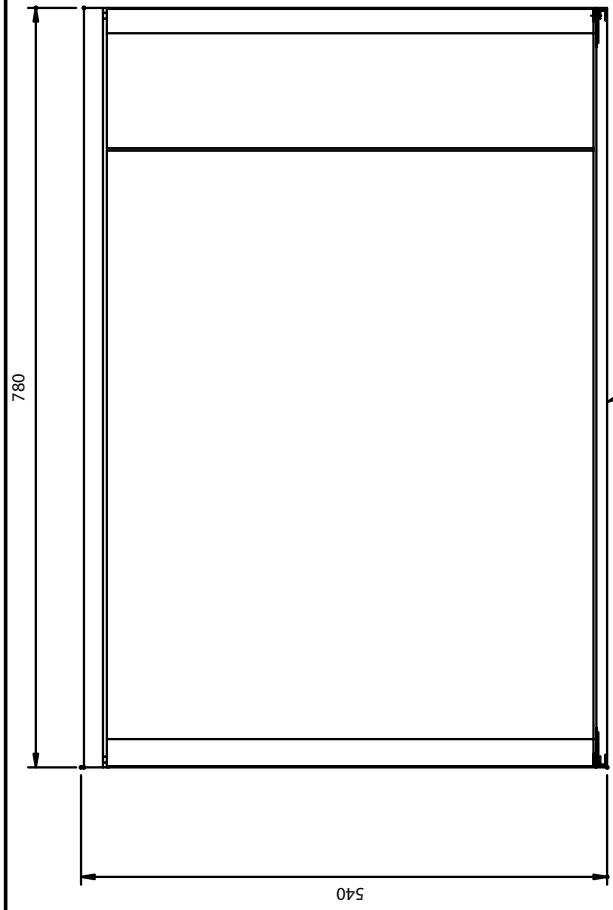

CONDENSE WATER DRAIN

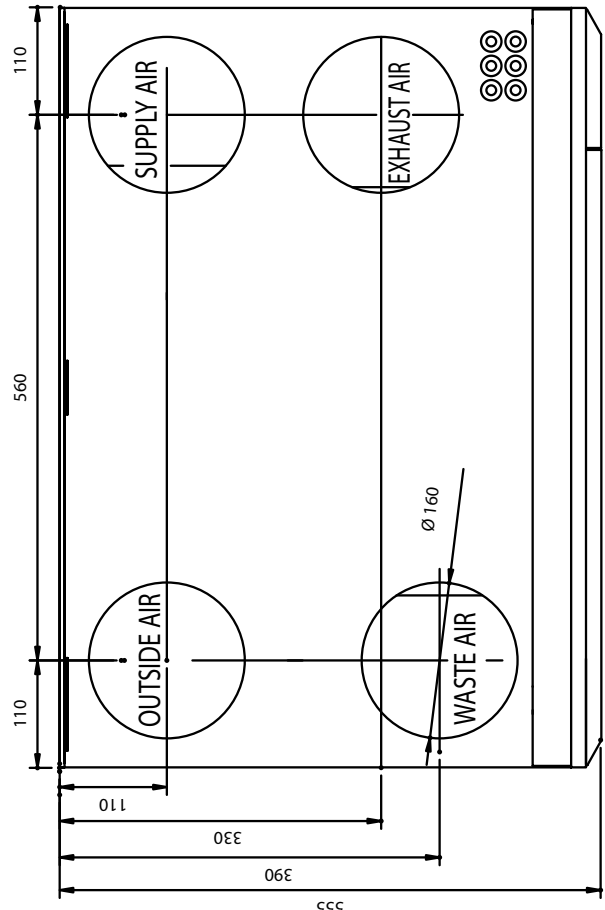

SERVICE HATCH

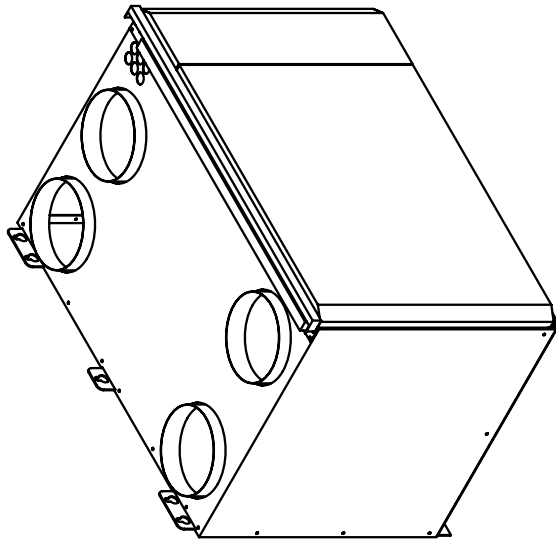
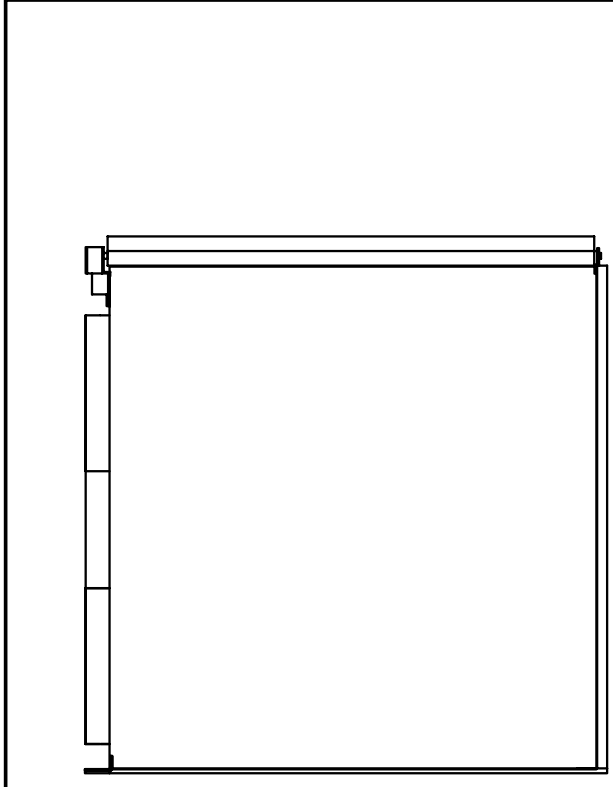

Piirt. J.T.	Tark.	Hyv.	File L:\VAKOIT\PINGVIN\03\PINGVIN\SUUN	Pvm 20090325	Suhde 1:7
PINGVIN ECO XL			Nimitys DIMENSION DRAWING	Paino.kg	
powered by enervent			Piir.no EVOLUTION	Muutos C	Lehti 1

No	Muutos	Pvm	Muutt	Hyv	20020507
----	--------	-----	-------	-----	----------

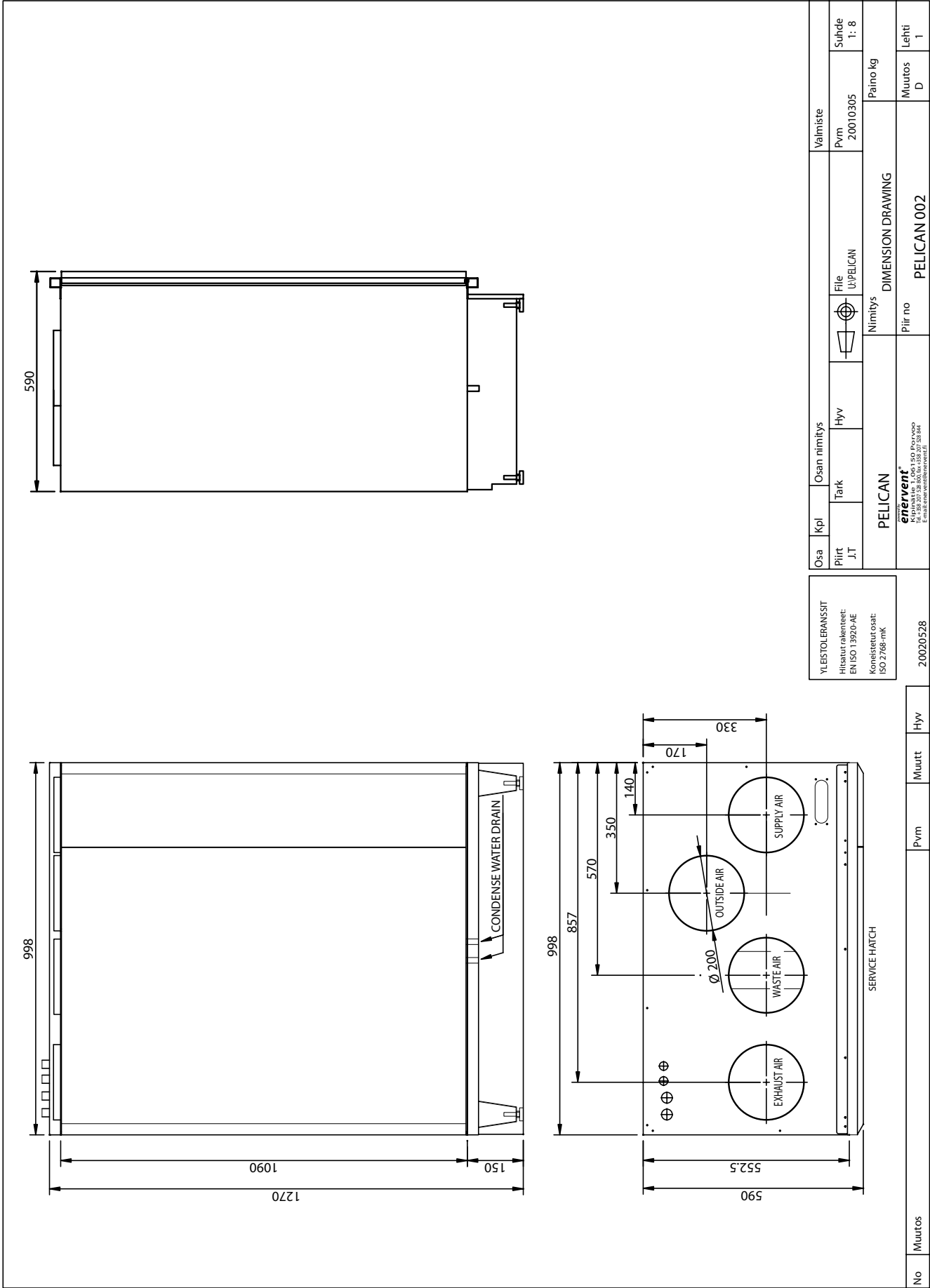

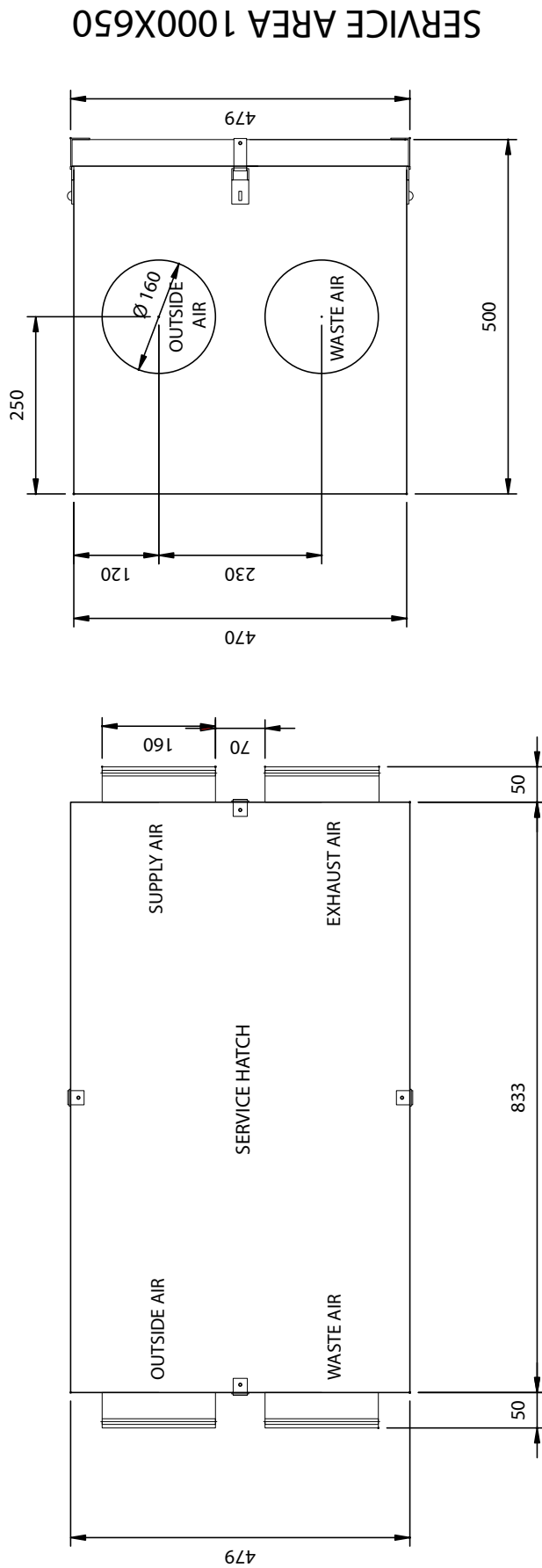

SERVICE AREA 1000X650

ALL DUCT CONNECTIONS Ø160 mm
 25mm INSULATION PV-IPL (mineral wool)
 MOUNTING WITH SERVICE HATCH UPWARDS OR TO THE SIDE

YLEISTOLERANSSIT Hitsatut rakenteet: EN ISO 13920-AE Koneistretut osat: ISO 2768-mK		Osa	Kpl	Osan nimitys	Valmistaja	Valmistus Pvm 1997/0527	Suhde 1:6
Piirt DG	Tark	Hyv	File t:\2\Pienkone\032LTR3\	Nimitys DIMENSION DRAWING	Paino kg	Muutos A	Lehti 1
LTR-3		Piirt no 2 032 006					
powered by enervent Minerali, 0611000000 Tel: +358 (0)20 7 528800 Fax: +358 (0)20 7 528801 Email: info@enervent.fi		No		Muutos	Pvm	Muutt	Hyv

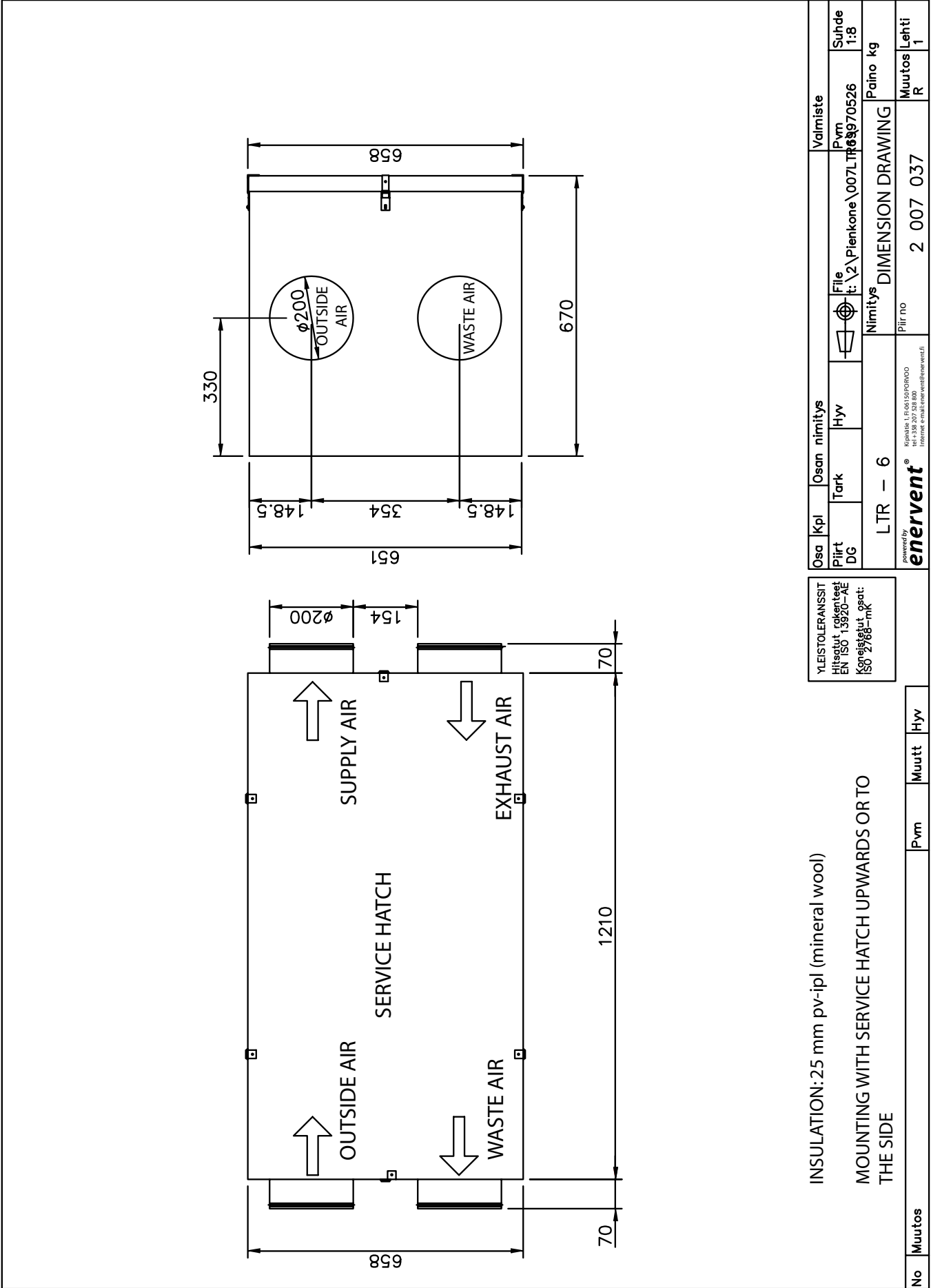

INSULATION: 25 mm pv-ipl (mineral wool)
 MOUNTING WITH SERVICE HATCH UPWARDS OR TO THE SIDE

YLEISTOLERANSSIT
 Hitsäätötoleranssit
 EN ISO 15920-AE
 Käyttötoleranssit
 ISO 2768-MK

Osa	Kpl	Osa nimitys	Valmistaja
Piirt	Tark	Hyv	Pvm
DG			File
LTR - 6			Path: \\Pienkone\007LITR\09970526
Nimitys			Paino kg
DIMENSION DRAWING			
Pir no			Muutos
2 007 037			R
Kuvaus: I:\005\007000			Lehti
Internet: e-mail: enervent@enervent.fi			1

No Muutos

Pvm Muutt Hyv

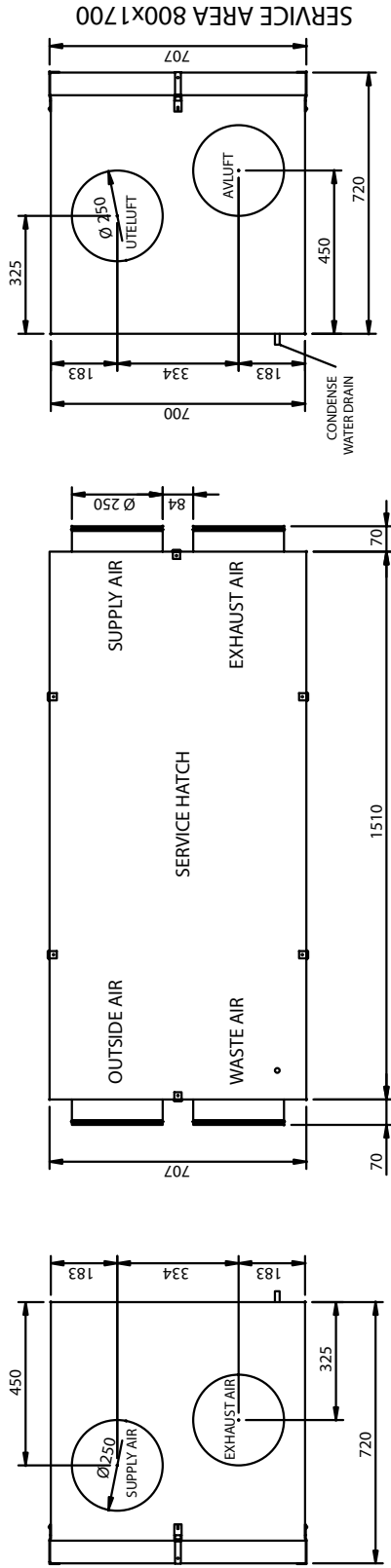

ALL DUCT CONNECTIONS Ø 250 mm
50 mm INSULATION PV-IPL (MINERAL WOOL)

Osa		Kpl	Osan nimitys		Valmistaja		Suhde	
Piirit J.T.		Tark	Hyv	File	Pvm	Paino kg		Lehti
LTR - 7				UUVAKIO TLTR-S007LTR7	20030526	1.8		1
Nimitys					DIMENSION DRAWING			
Plir no					LTR 7-001			
Muutos					Muutos			
No					B			

YLEISTOLERANSSIT		20020822	
Ehkäistyt rakenteet:			
EN ISO 15920-AE			
Koneistettut osat:			
ISO 2768-mK			

powered by		enervent®	
Kipinätie 1, 04410 Porvoo			
Puh. 358 03207, 528884			
Email: enervent@enervent.fi			

HEAT RECOVERY EFFICIENCY

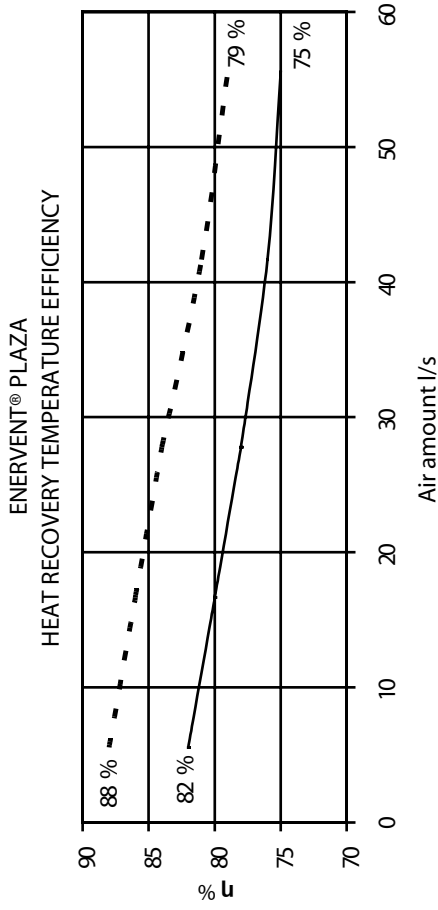

— Supply/exhaust air ratio 1.0 - - - Supply/exhaust air ratio 0.85

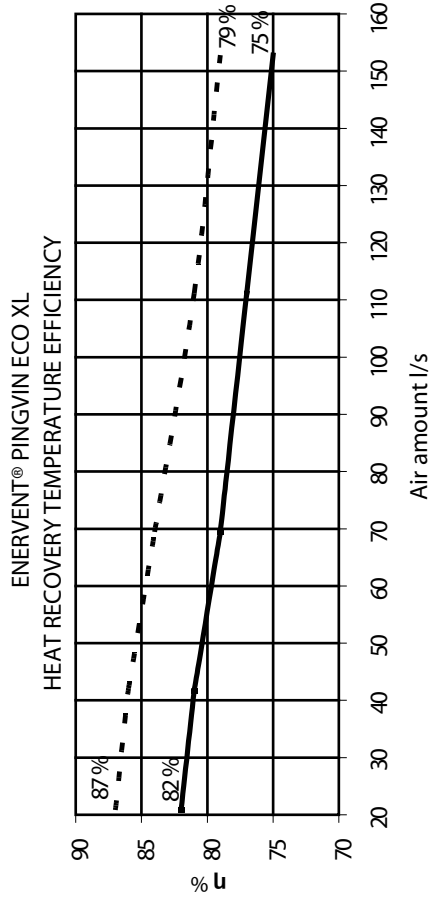

— Supply/exhaust air ratio 1.0 - - - Supply/exhaust air ratio 0.85

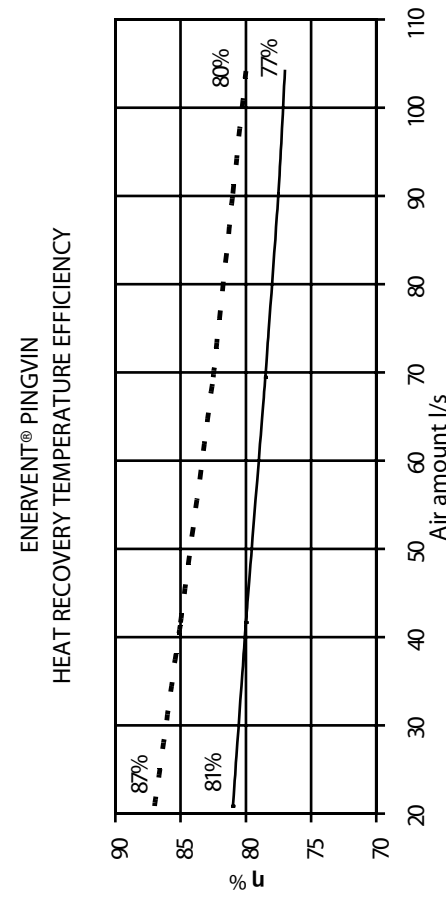

— Supply/exhaust air ratio 1.0 - - - Supply/exhaust air ratio 0.85

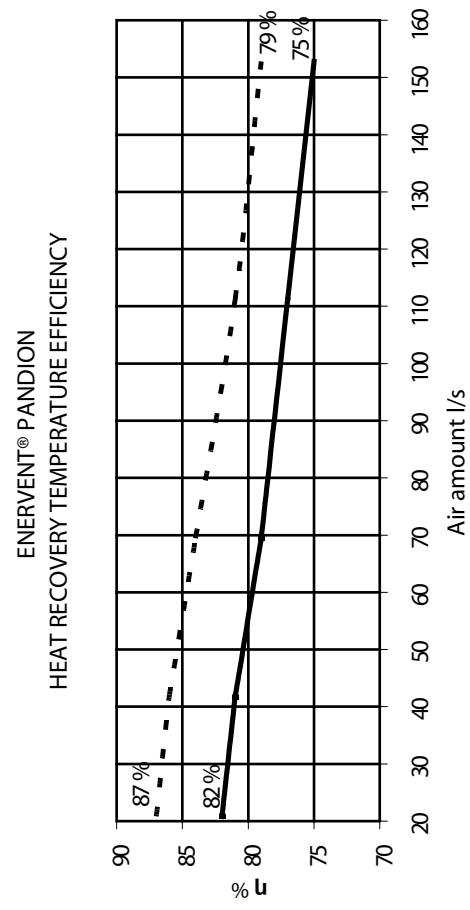

— Supply/exhaust air ratio 1.0 - - - Supply/exhaust air ratio 0.85

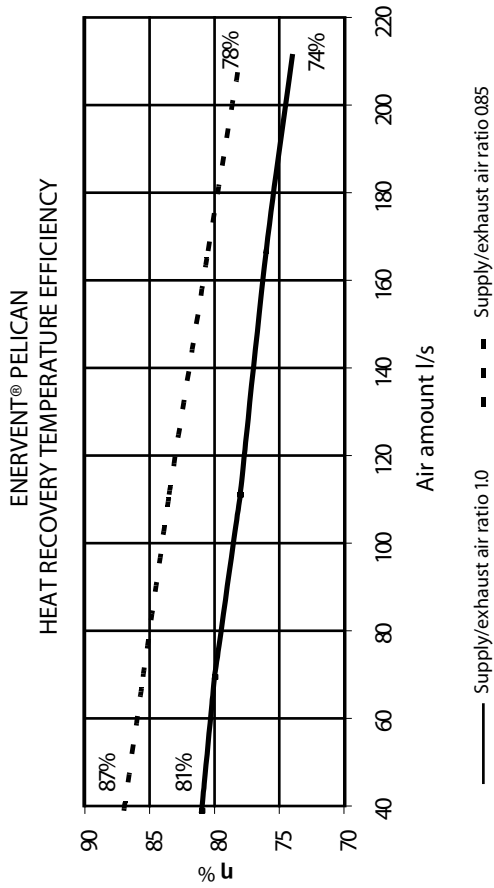
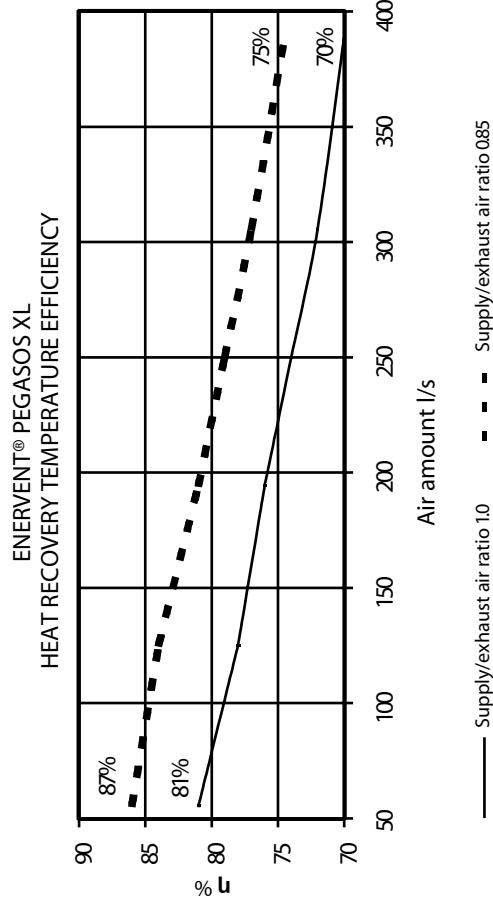
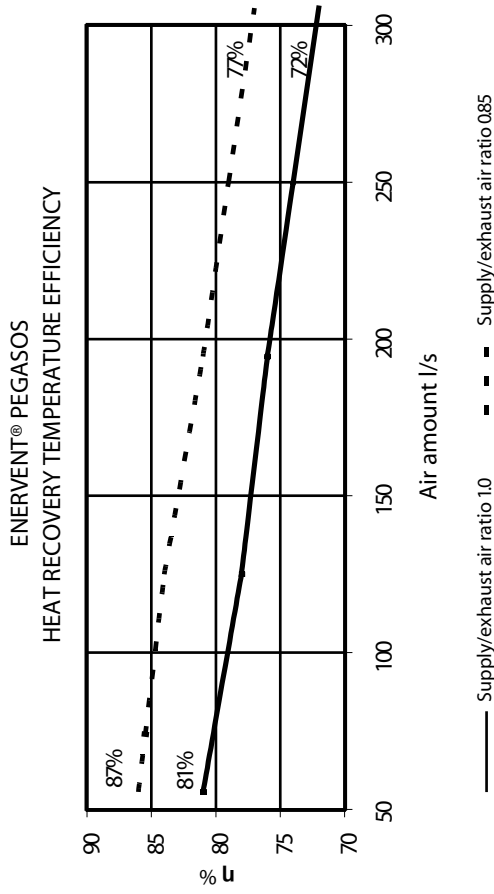

ENERVENT® LTR-7
HEAT RECOVERY TEMPERATURE EFFICIENCY

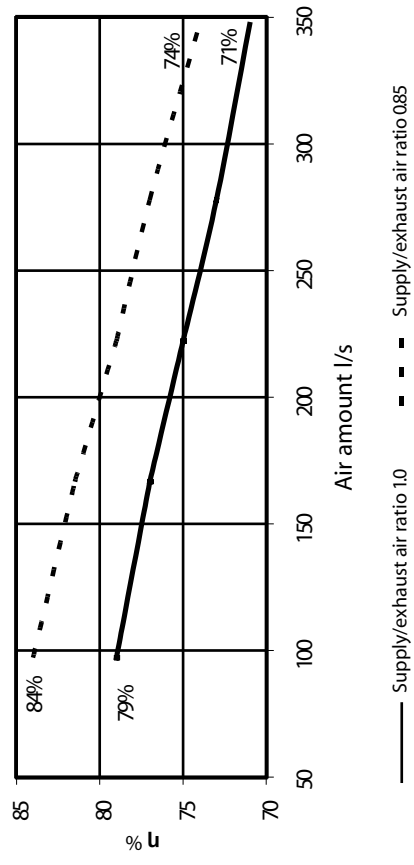

ENERVENT® LTR-3
HEAT RECOVERY TEMPERATURE EFFICIENCY

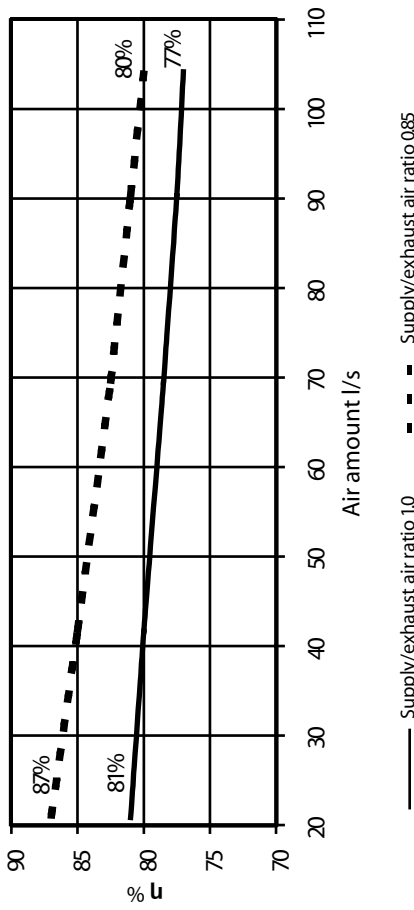

ENERVENT® LTR-7-XL
HEAT RECOVERY TEMPERATURE EFFICIENCY

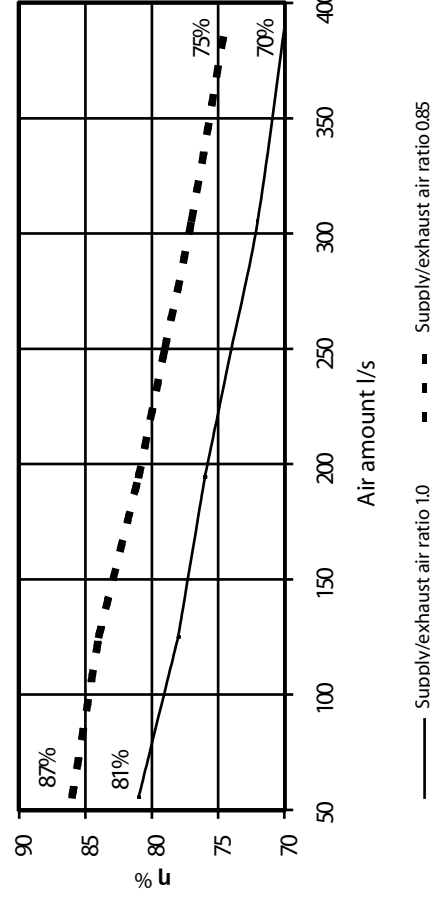

ENERVENT® LTR-6
HEAT RECOVERY TEMPERATURE EFFICIENCY

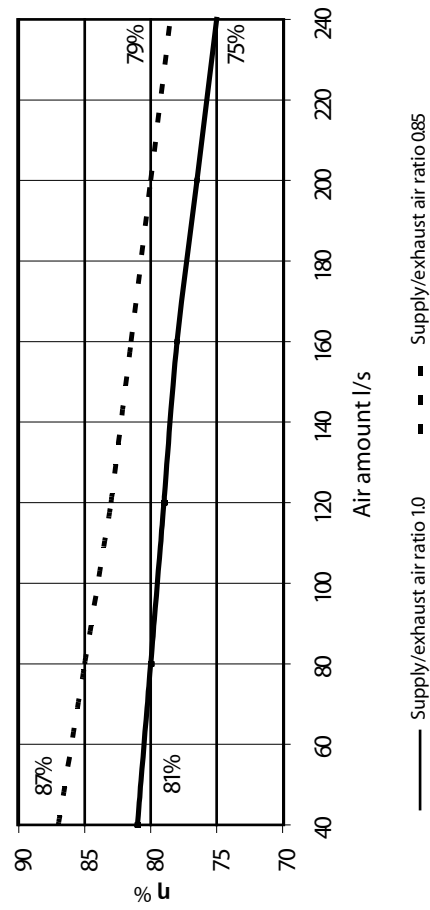

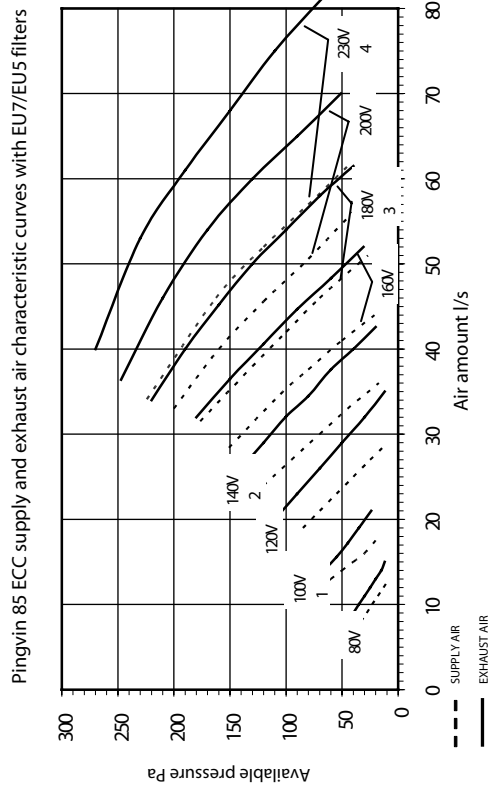
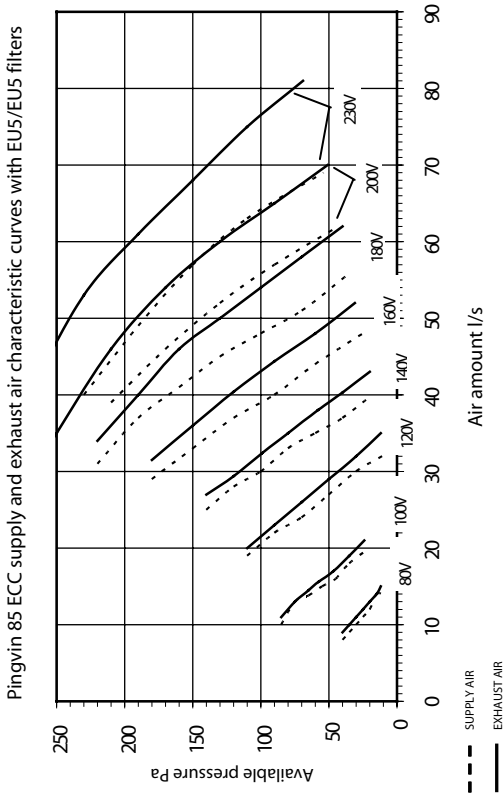
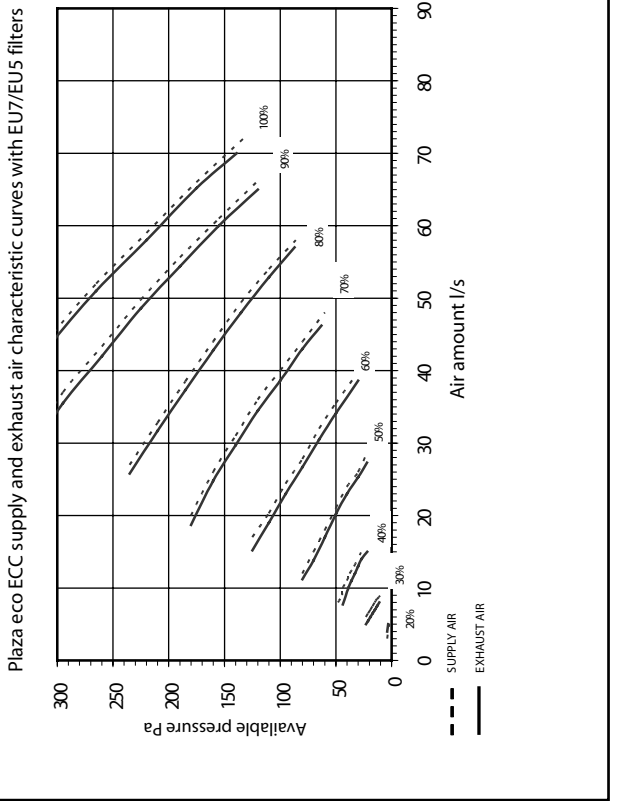

The electrical power of the fans can be calculated using the energy calculating program Enervent Energy Optimizer on our web site www.enervent.fi

Pingvin eco ECC supply and exhaust air characteristic curves with EU5/EU5 filters

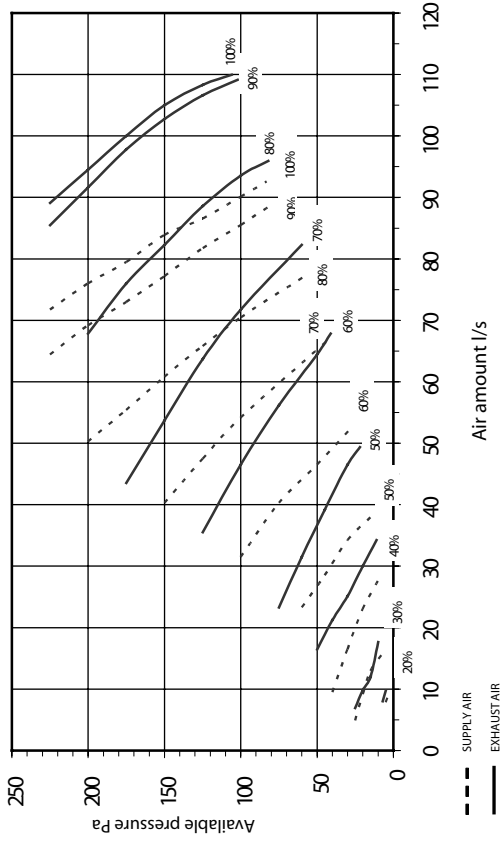

Pingvin eco ECC supply and exhaust air characteristic curves with EU7/EU5 filters

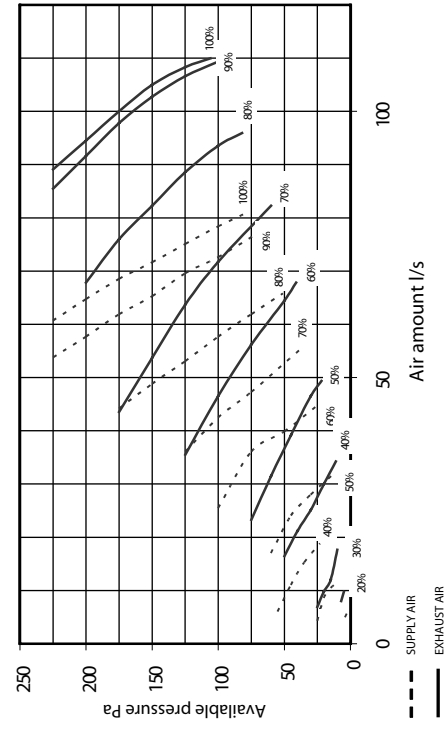

Pingvin 120 ECC supply and exhaust air characteristic curves with EU5 filters

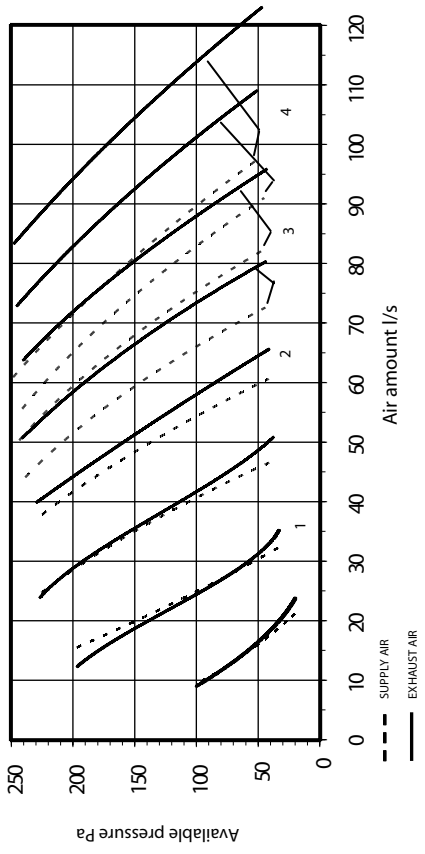

Pingvin 120 ECC supply and exhaust air characteristic curves with EU7/EU5 filters

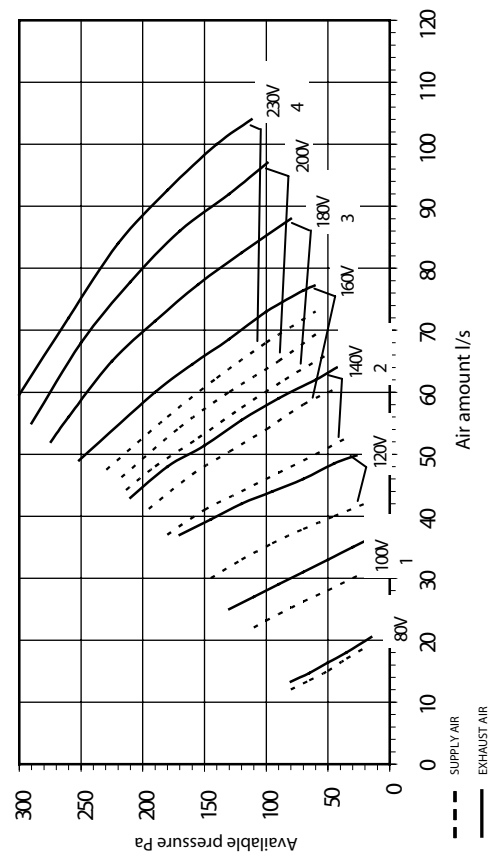

Pingvin eco XL ECC supply and exhaust air characteristic curves F5/F5 filter

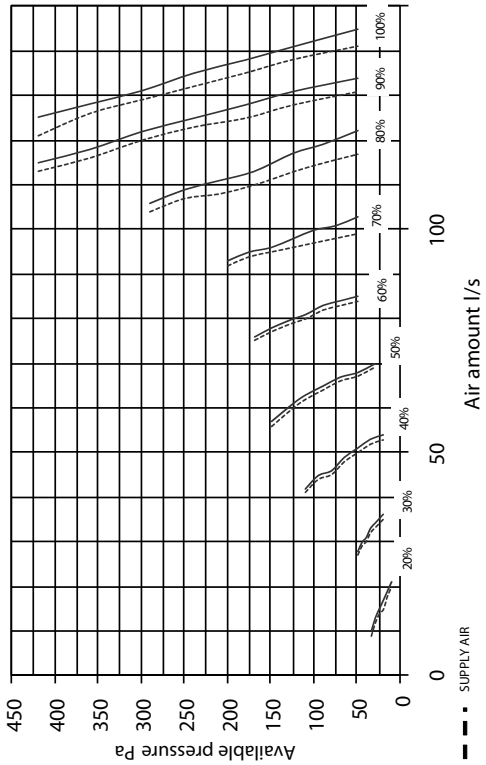

Pingvin eco XL ECC supply and exhaust air characteristic curves with F7/F7 filter

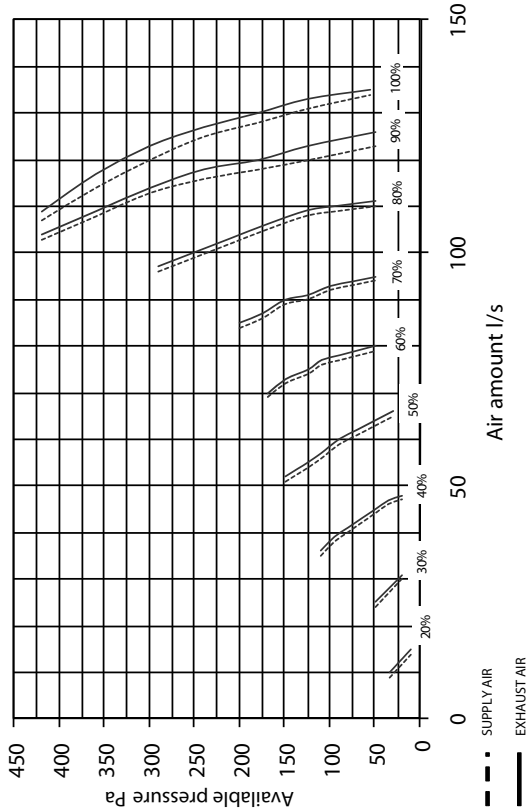

Pandion eco ECC supply and exhaust air characteristic curves with EU5/EU5 filters

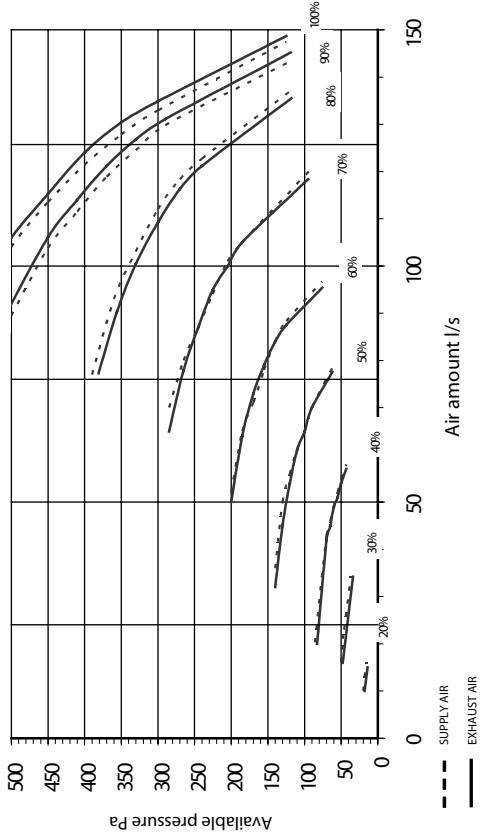

Pandion eco ECC supply and exhaust air characteristic curves with EU7/EU7 filters

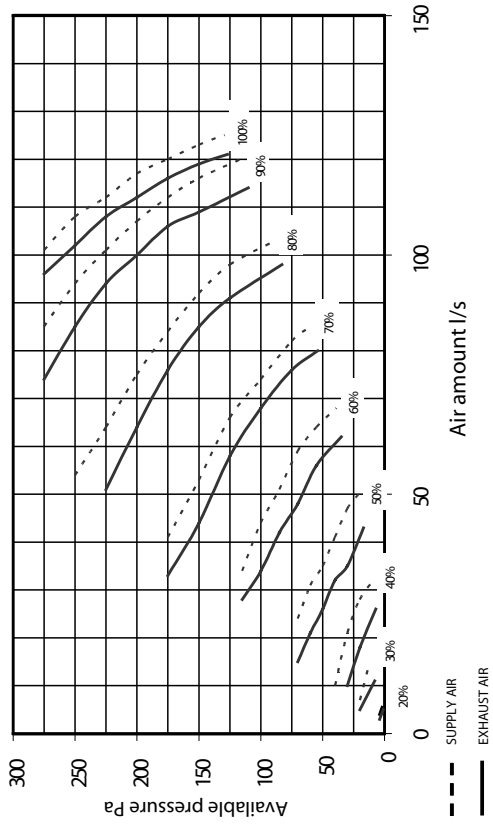

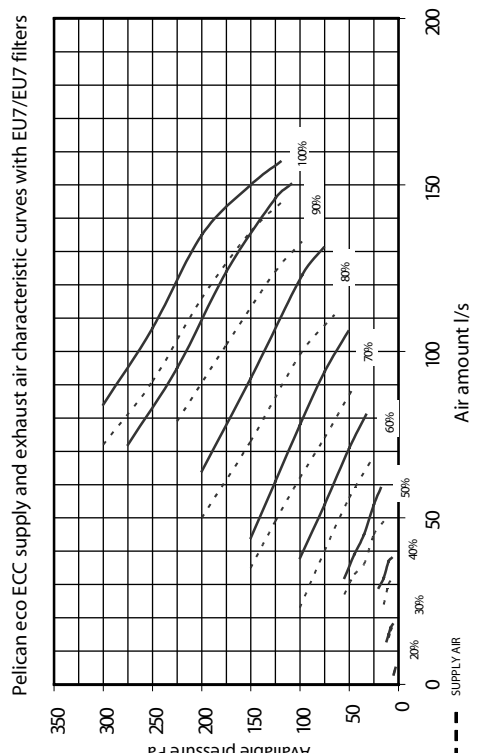
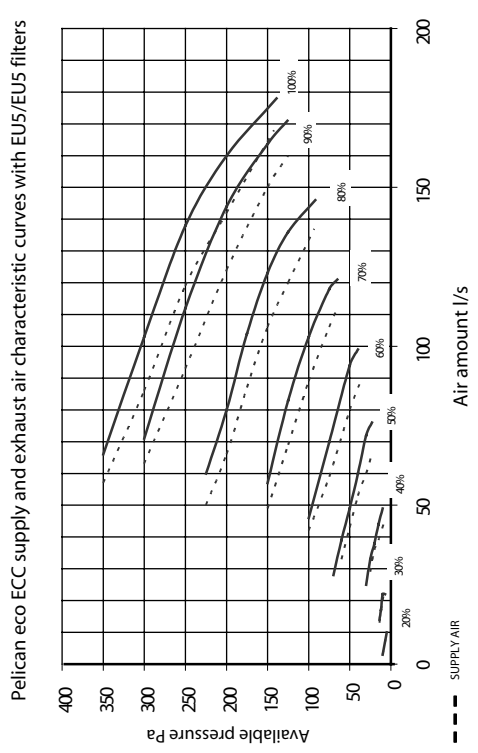
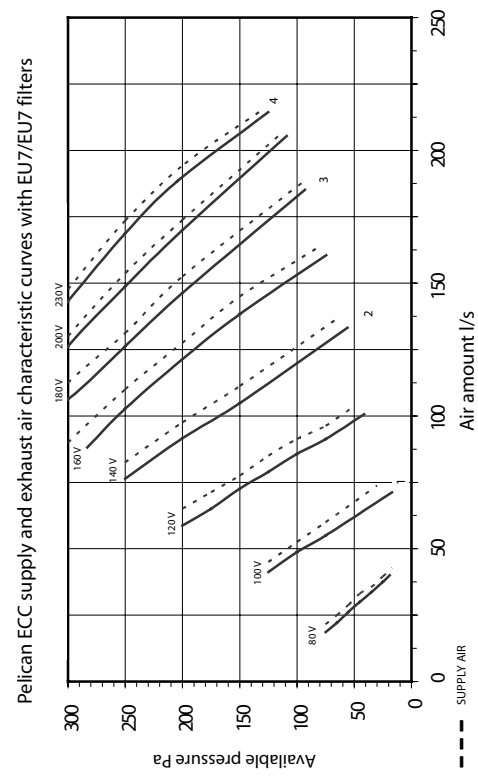
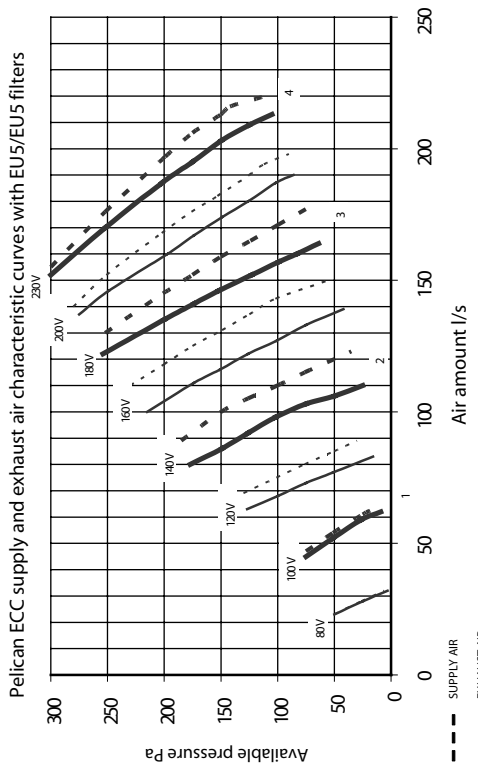

Pegasos eco ECC supply and exhaust air characteristic curves with EU5/EU5 filters

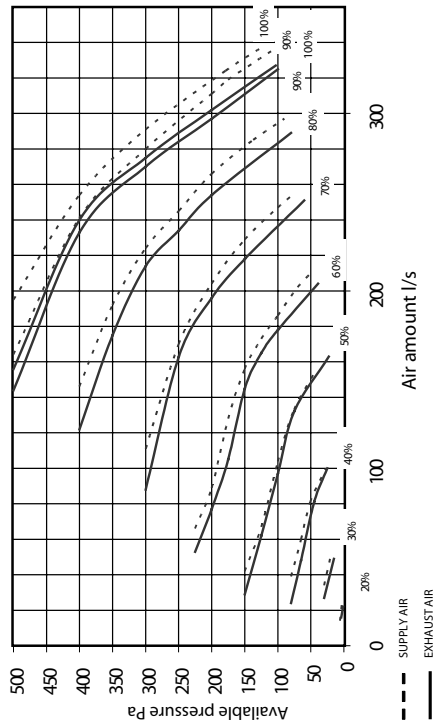

Pegasos eco ECC supply and exhaust air characteristic curves with EU7/EU7 filters

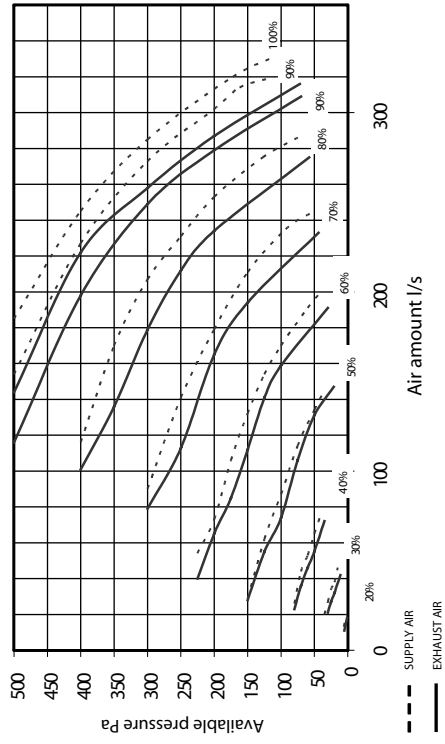

Pegasos XL ECC supply and exhaust air characteristic curves with EU5/EU5 filters

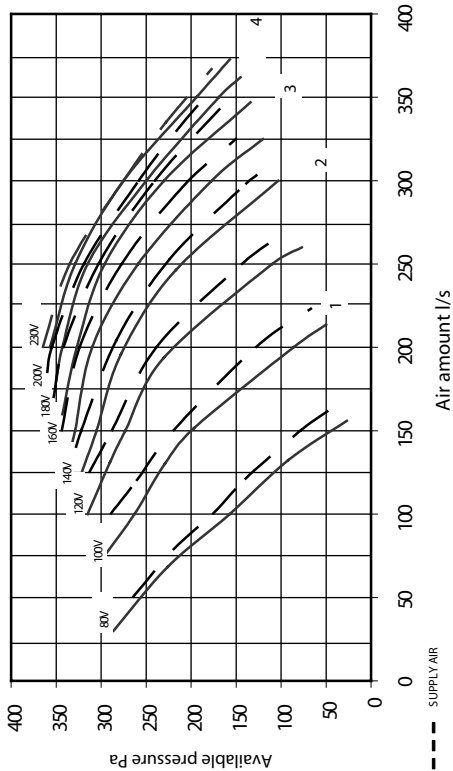

Pegasos XL ECC supply and exhaust air characteristic curves with EU7/EU7 filters

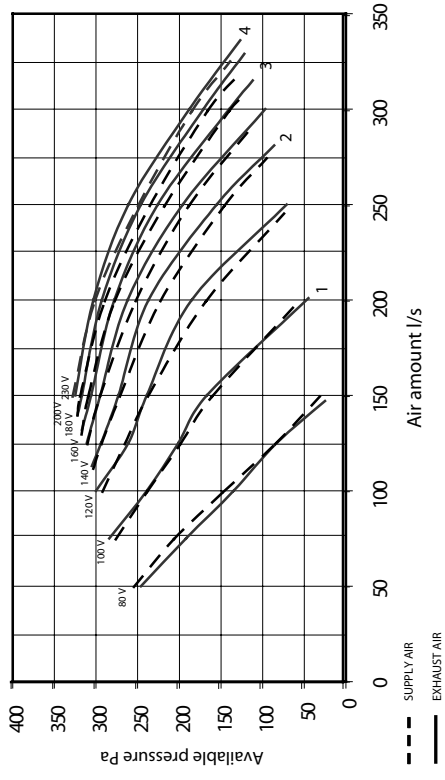

LTR-3-85 ECC supply and exhaust air characteristic curves with EU5/EU5 filters

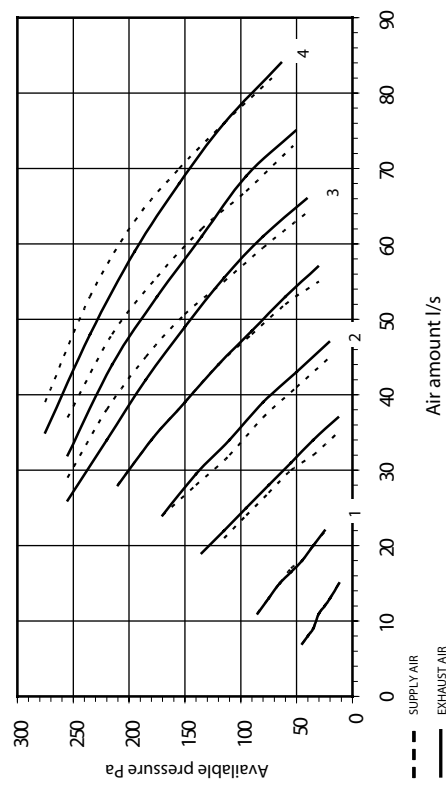

LTR-3-85 ECC supply and exhaust air characteristic curves with EU7/EU7 filters

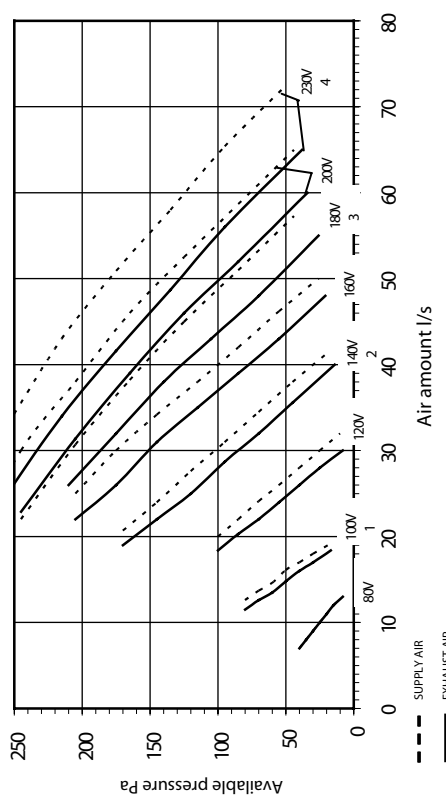

Pegasos eco XL ECC supply and exhaust air characteristic curves with EU5/EU5 filters

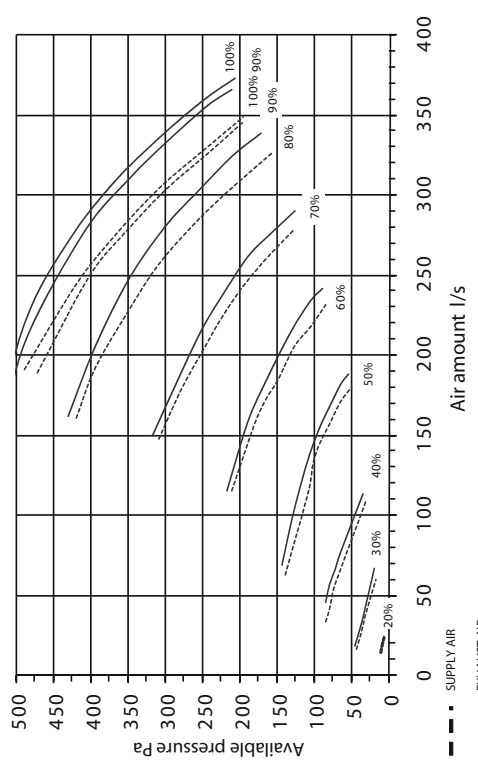

Pegasos eco XL ECC supply and exhaust air characteristic curves with F7/F7 filters

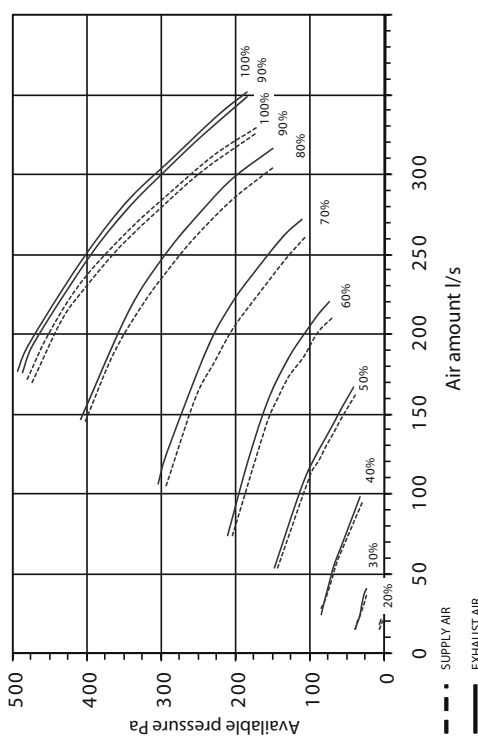

LTR-3 eco ECC supply and exhaust air characteristic curves with EU5/EU5 filters

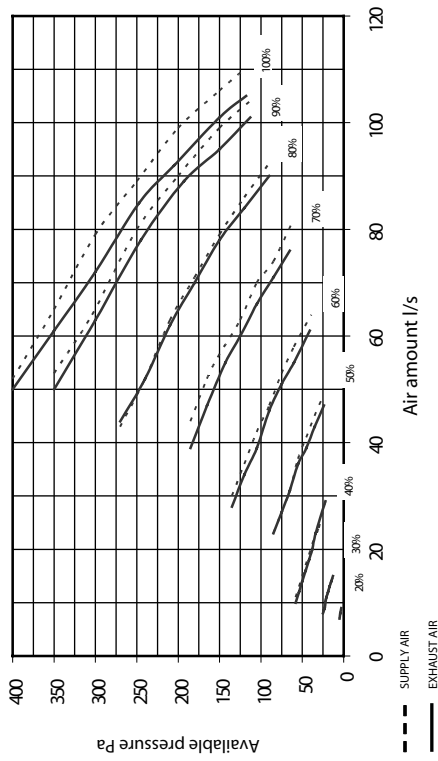

LTR-3 eco ECC supply and exhaust air characteristic curves with EU7/EU7 filters

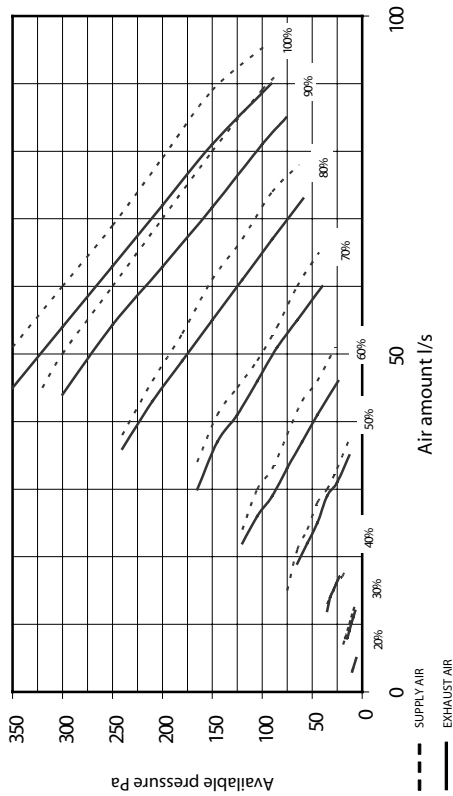

LTR-120 ECC supply and exhaust air characteristic curves with EU5/EU5 filters

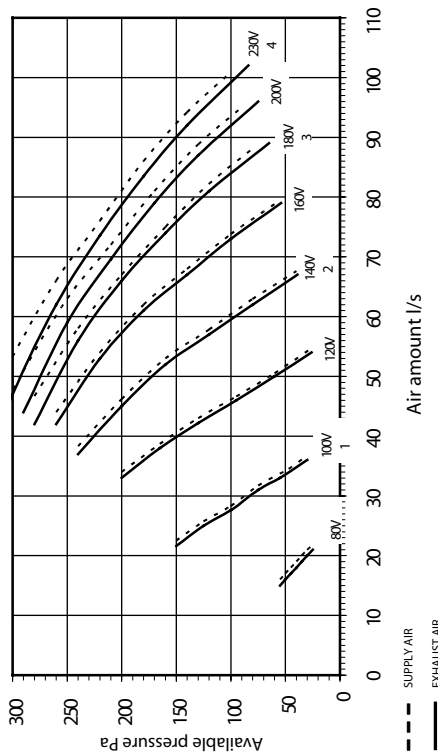

LTR-3-120 ECC supply and exhaust air characteristic curves with EU7/EU7 filters

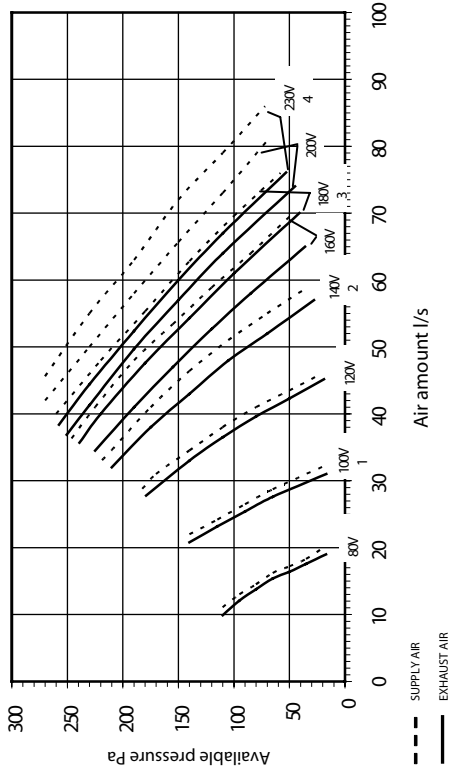

LTR-6 ECC supply and exhaust air characteristic curves with EU5/EU5 filters

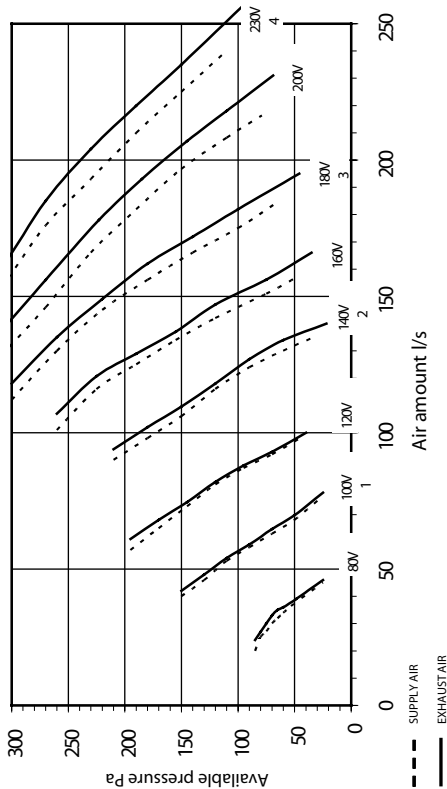

LTR-6 eco ECC supply and exhaust air characteristic curves with EU5/EU5 filters

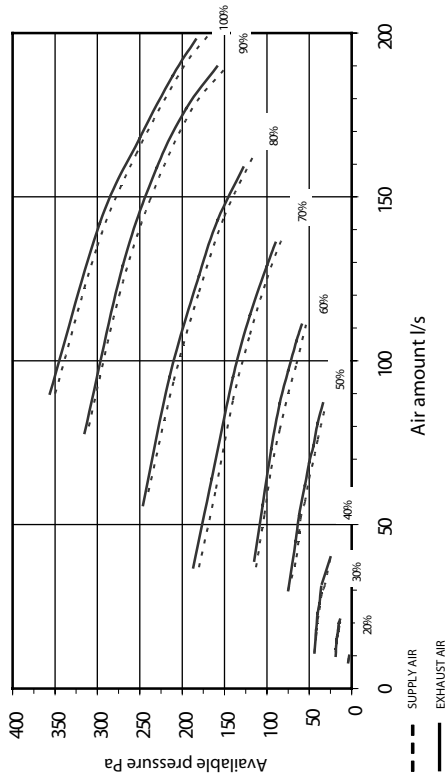

LTR-6 ECC supply and exhaust air characteristic curves with EU7/EU7 filters

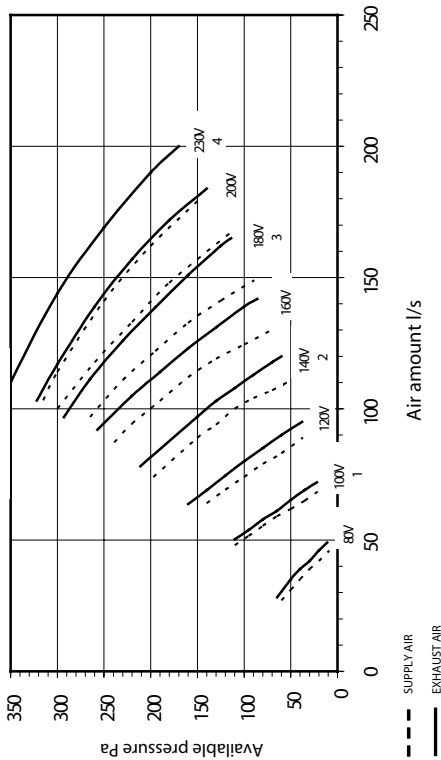

LTR-6 eco ECC supply and exhaust air characteristic curves with EU7/EU7 filters

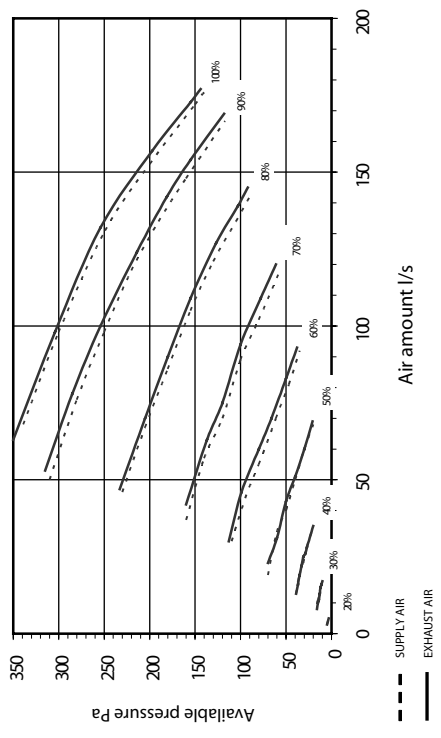

LTR-7 ECC supply and exhaust air characteristic curves with EU5/EU5 filters

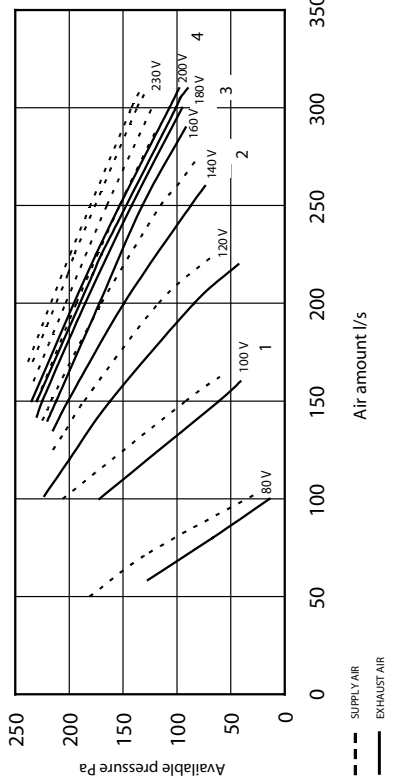

LTR-7-XL ECC supply and exhaust air characteristic curves with EU5/EU5 filters

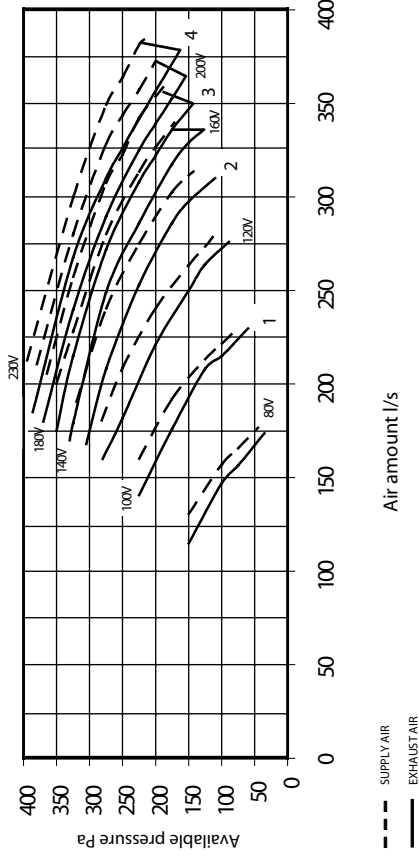

LTR-7 ECC supply and exhaust air characteristic curves with EU7/EU7 filters

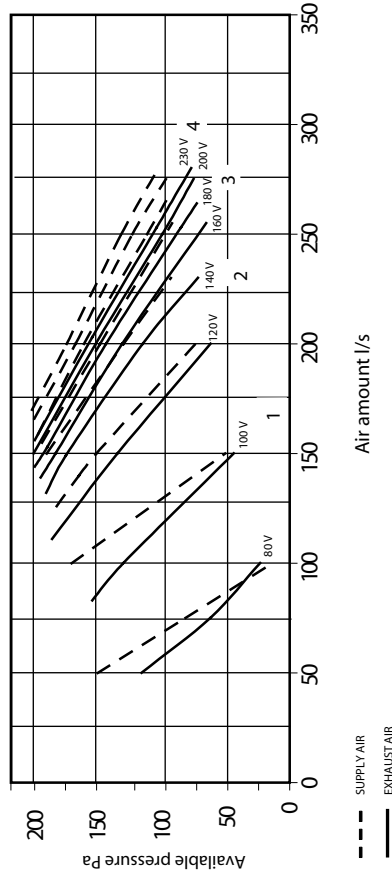

LTR-7-XL ECC supply and exhaust air characteristic curves with EU7/EU7 filters

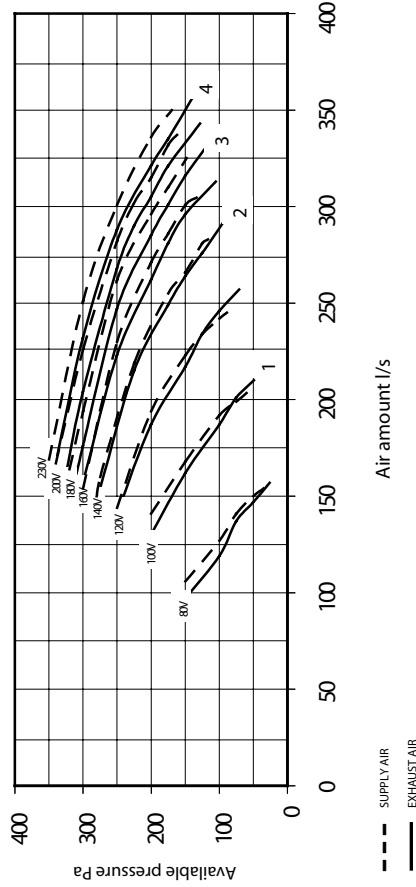

LTR-7 eco ECC supply and exhaust air characteristic curves with EU5/EU5 filters

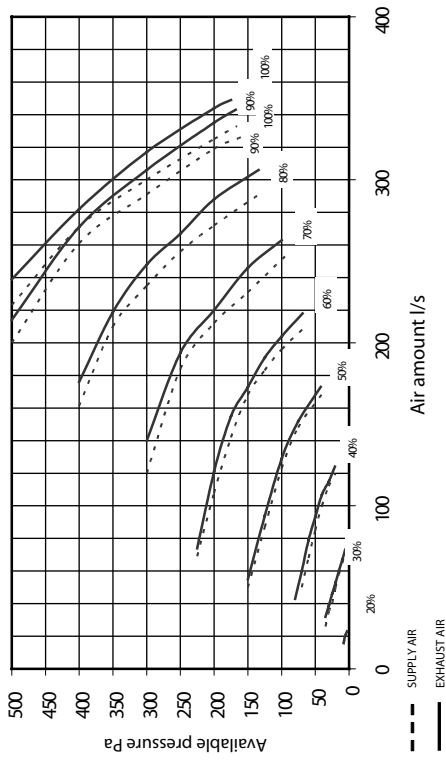

LTR-7 eco ECC supply and exhaust air characteristic curves with EU7/EU7 filters

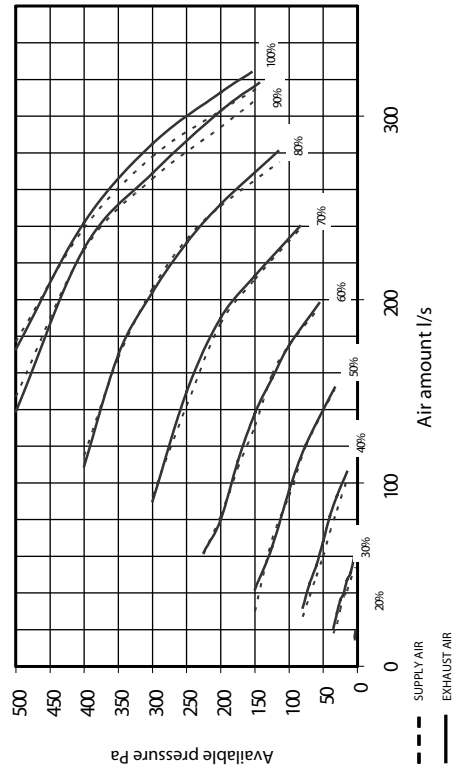

LTR-7 eco XL ECC supply and exhaust air characteristic curves with EU5/EU5 filters

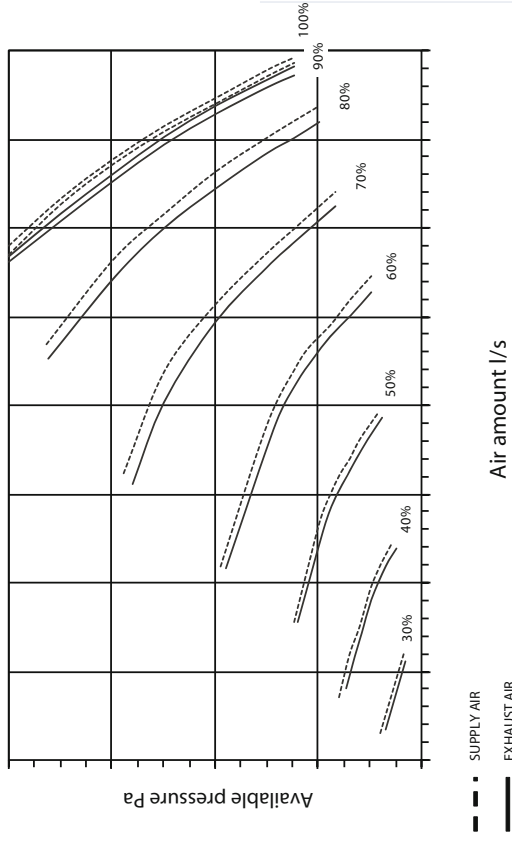

LTR-7 eco XL ECC supply and exhaust air characteristic curves with EU7/EU7 filters

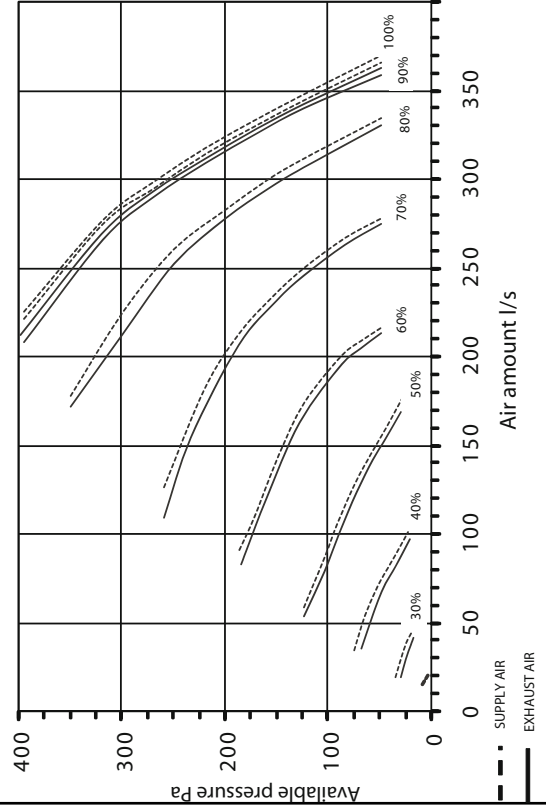

OUTER WIRING

WIRING, max. 35 V

Connector type	Internal	ELV Connector	max. 35 V External			
Screw		NO		Alarm output, potential free max 35V or 250V		
Screw		COM		Alarm output, potential free max 35V or 250V		
Screw		NC		Alarm output, potential free max 35V or 250V		
Screw		COM				
Screw		LTOC		External input, cooling recovery		
Screw		STOP		External input, emergency stop		
Screw		S1		External input, fan speed 1		
Screw		S2		External input, fan speed 2		
Screw		S3		External input, fan speed 3		
Screw		S4		External input, fan speed 4		
Screw		OVERP		External input (push button), over pressure		
Screw		OVERP				
Screw		ALARM		External alarm input (fire, freezing protection)		
Screw		ALARM				
Quick				T1		Outside air temperature sensor
Quick				T1		
Quick	T2			Supply air temperature sensor between heat recovery and supply fan		
Quick	T2					
Quick	T3			Supply air temperature sensor		
Quick	T3					
Quick	AFT HEAT			Control for electrical after heater (ECE-models)		
Quick	AFT HEAT		Control for electrical after heater (ECE-models)			
Quick	AFT HEAT		Control for electrical after heater (ECE-models)			
Quick	AFT HEAT		Control for electrical after heater (ECE-models)			

WIRING, max. 250 V

Connector type	Internal	Connector	max. 250 V External	
Screw		PE	←	Earth to the AHU
Screw	N	IN	←	Neutral to the AHU
Screw	N	SW	→	To Door switch / Main switch
Screw	L	IN	←	230 VAC, 50 Hz supply to the AHU
Screw	L	SW	→	To Door switch / Main switch
Screw		L	←	From Door switch / Main switch
Screw		L	→	230 VAC, 50 Hz after main switch / door switch
Screw		L	→	230 VAC, 50 Hz after main switch / door switch
Screw		L	→	230 VAC, 50 Hz after main switch / door switch
Screw		L	→	230 VAC, 50 Hz after main switch / door switch
Screw		N	←	From door switch / main switch
Screw		N	→	Neutral after main switch / door switch
Screw		N	→	Neutral after main switch / door switch
Screw		N	→	Neutral after main switch / door switch
Screw		N	→	Neutral after main switch / door switch
Screw	LTO	N	→	Neutral for heat recovery motor
Screw	LTO	E	→	230 VAC for heat recover motor
Screw	AFT HEAT	N	→	Neutral for electrical heater (ECE-models)
Screw	AFT HEAT	L	→	230 VAC for electrical heater (ECE-models)
Screw	PFC	Z	→	Capasitor for exhaust air fan
Screw	PFC	CAP	→	Capasitor for exhaust air fan
Screw	PFC	N	→	Neutral for exhaust air fan
Screw	PFC	L	→	100...230 VAC for exhaust air fan
Screw	TFC	Z	→	Capasitor for supply air fan
Screw	TFC	CAP	→	Capasitor for supply air fan
Screw	TFC	CAP	→	Capasitor for supply air fan
Screw	TFC	N	→	Neutral for supply air fan
Screw	TFC	L	→	60..230 VAC for supply air fan
Quick	TRANSFORMER		→	N for fan transformer
Quick	TRANSFORMER		→	230 VAC for fan transformer
Quick	TRANSFORMER		←	230 VAC from fan transformer
Quick	TRANSFORMER		←	180 VAC from fan transformer
Quick	TRANSFORMER		←	140 VAC from fan transformer
Quick	TRANSFORMER		←	100 VAC from fan transformer
Quick	TRANSFORMER		←	60 VAC from fan transformer

WIRING DIAGRAMS

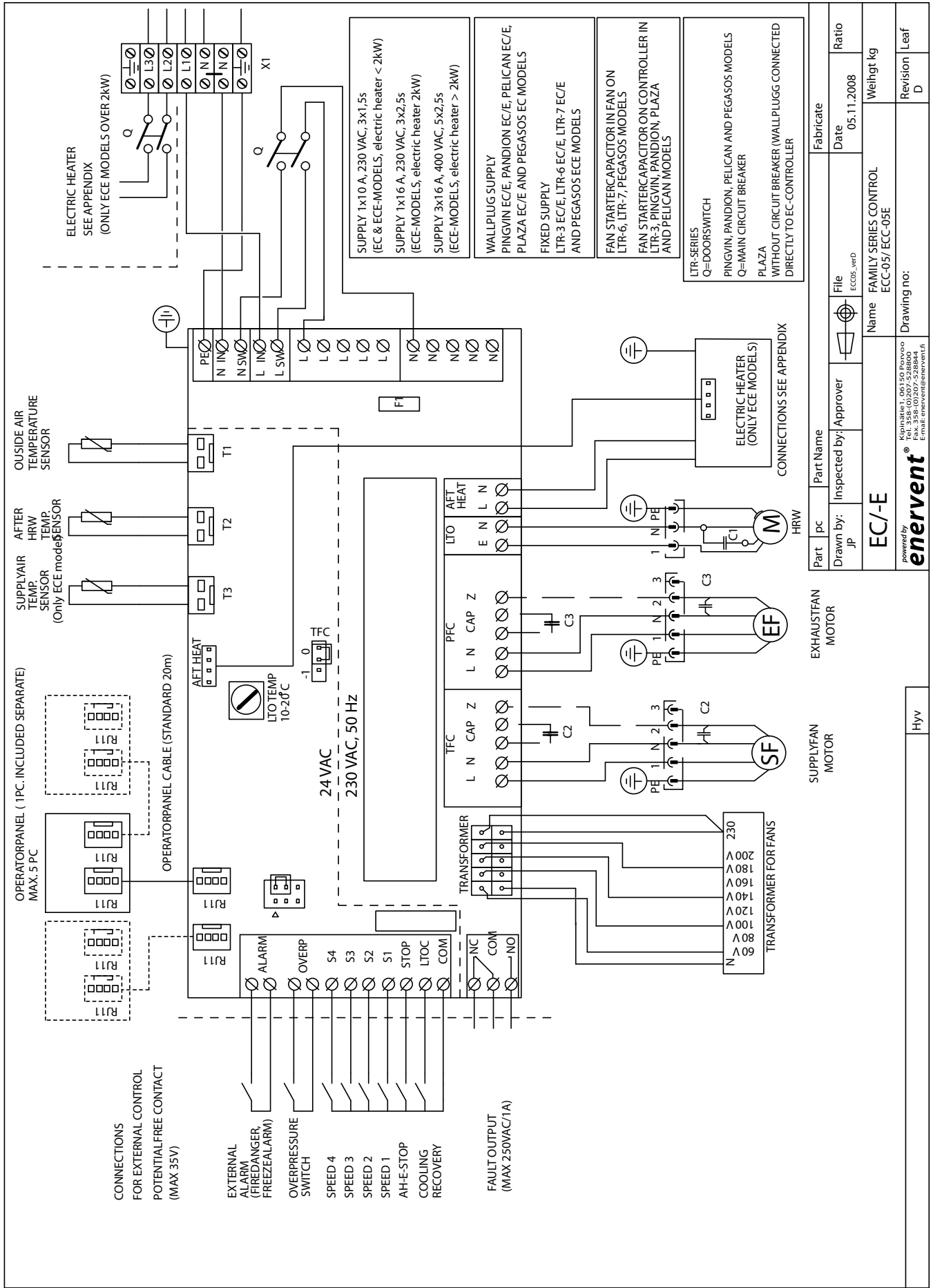

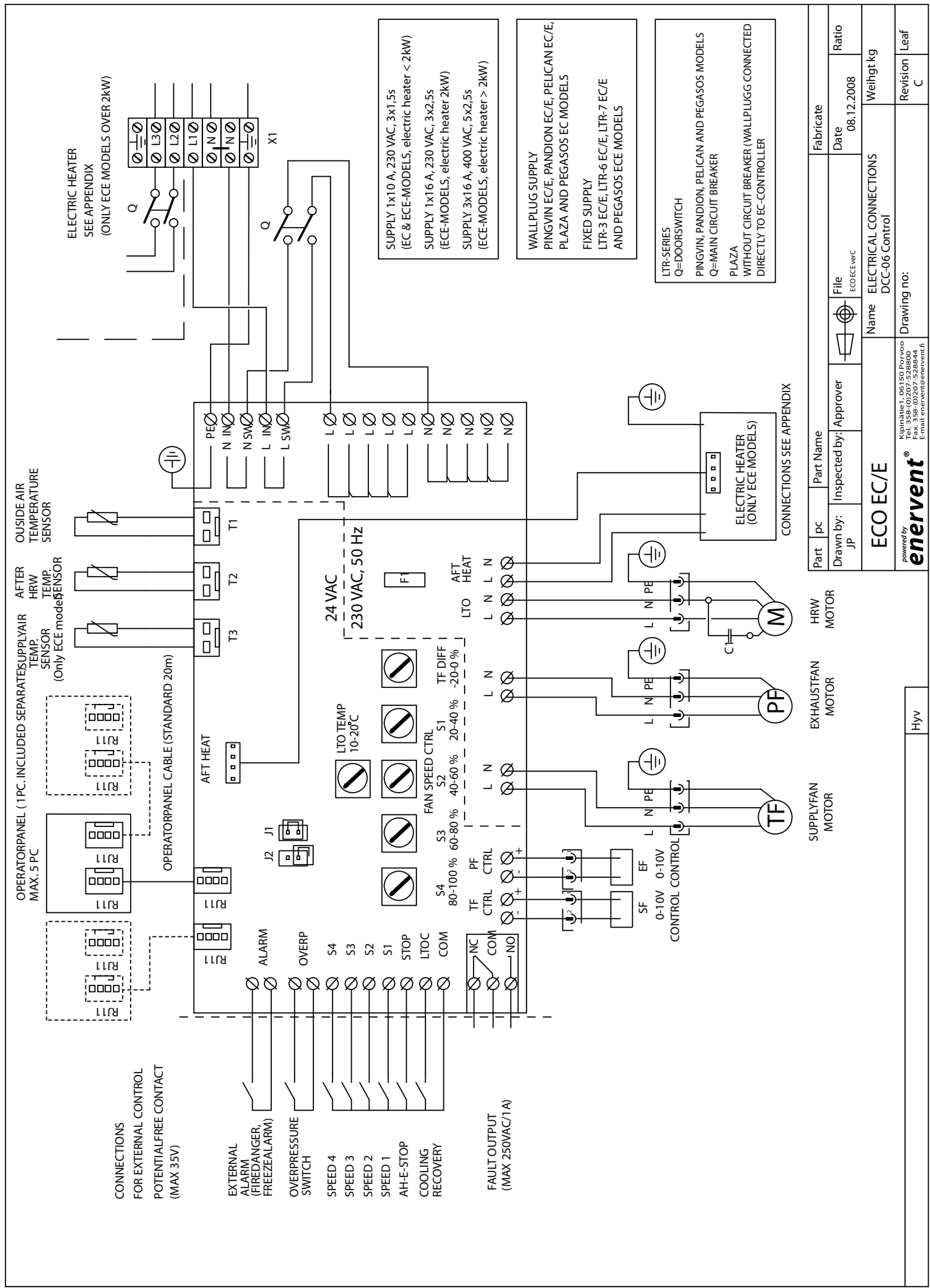

Part	pc	Part Name	Fabricate
Drawn by:	JP	Inspected by:	Approver
File	ECO ECE-WE	Date	08.12.2008
Name	ELECTRICAL CONNECTIONS		
Drawing no:		Weight	kg
DCC-06 Control		Revision	C
powered by enervent		Leaf	

Kipparite 06150 Pervoo
 Tel. 358-10207-528800
 Fax 358-10207-528801
 Email: info@enervent.fi

HEAT RECOVERY DEFROSTING FUNCTION

The defrosting of the heat recovery is active when the outside air temperature is lower than -15°C. The temperature is checked every other hour (with 120 minutes interval). The supply air fan stops and the exhaust air fan runs on speed 3 when the defrosting is active. The defrosting is active at the most 8 % of the time. The over pressure function over rides the defrosting function.

The defrosting function is activated by short circuiting the defrosting pins on the main board. The defrosting is in active when the unit leaves the factory.

ECC units (with alternating current fans):

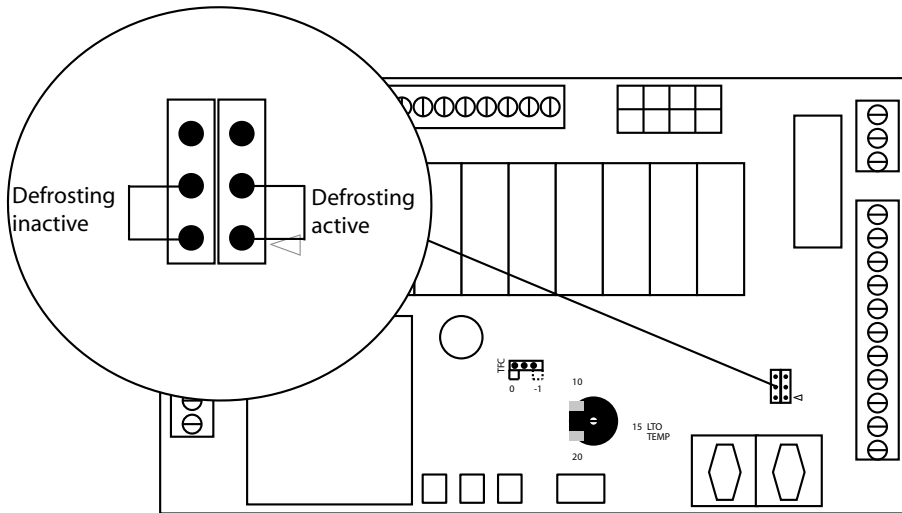

eco ECC units (with direct current fans):

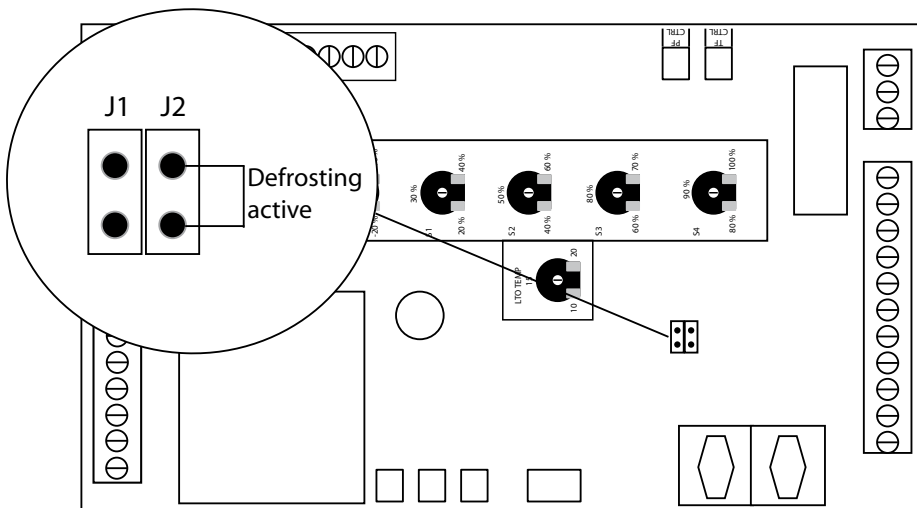

RU=RUSKEA/BRUN/BROWN
 SI=SIININEN/BLÅ/BLUE
 KeVI=KELTAVIHREÄ/GULGRÖN/YELLOWGREEN

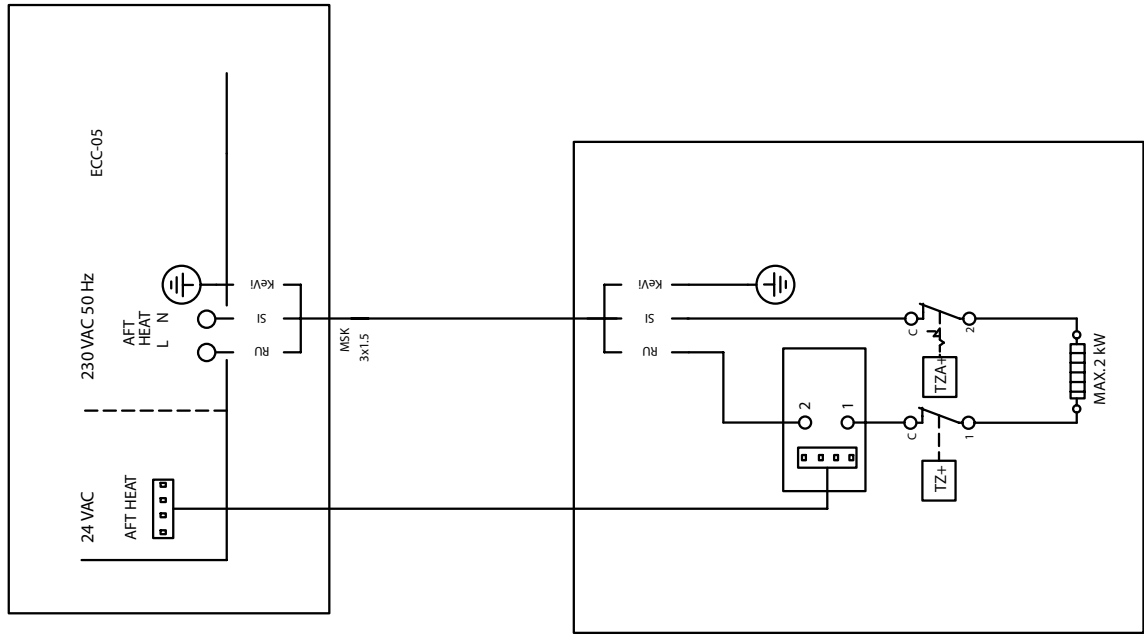

Piirt	Tark	Hyv	File	Pvm	Suhde
NEF				21.12.2007	1:1
ECC-05			Nimitys	Paino kg	
ECE-MALLIT/MODELLER/MODELS MAX. 2KW			LÄMMITIN/VÄRMARE/HEATER	Muutos	Lehti
powered by enervent			Piir no	A	1
No	Muutos	Pvm	Hyv	Muutt	

RU=RUSKEA/BRUN/BROWN
 SI=SIININEN/BLÅ/BLUE
 KeV=KELTAV/HREÁ/GULGRÖN/YELLOWGREEN
 MU=MUSTA/SVART/BLACK
 VA=VALKOINEN/VIT/WHITE
 LTR-SARJA/SERIEN/SERIES
 Q=OVIKYTKIN/DÖRRBRYTARE/DOORSWITCH
 PEGASOS
 Q=PAAKYTKIN/HUVDBRYTARE/MAINSWITCH

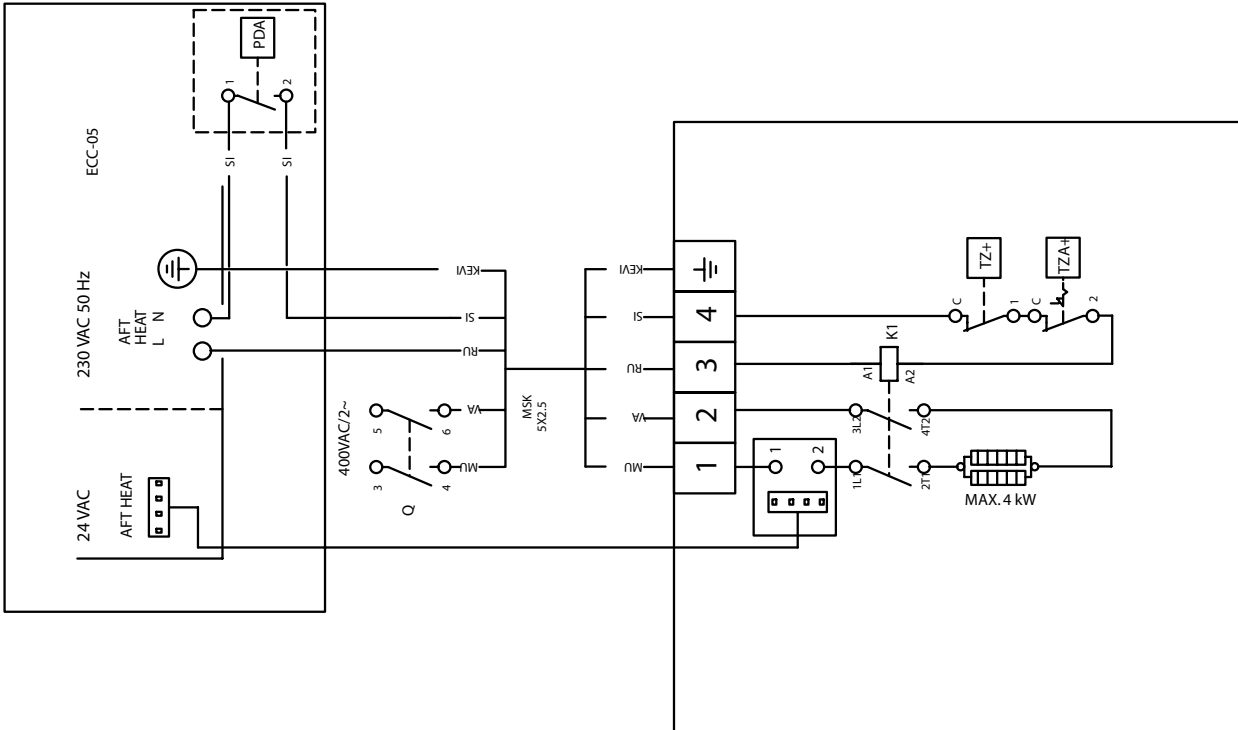

Osa		Osan nimitys		Valmistaja	
Piirt	NEF	Tark	Hyy	Pvm	04.06.2007
ECC-05		Nimitys		Paino kg	
ECE-MALLIT/MODELLER/MODELS 3-6 kW		LÄMMITIN/VÄRMARE/HEATER		Muutos	
powered by enervent		Piiir no		Lehti	
		<small> Osoitus: 05105, P.O. Box 1000 FIN-35810, 02007-528800 Fax: 358 (0)207-528844 Email: enervent@enervent.fi </small>			

DECLARATION OF CONFORMITY

We declare that our products follows the provisions of low voltage directive (LVD) 2006/95/EY, EMC-directive 2004/108/EY and machine directive (MD) 98/37/EY.

Manufacturer: Enervent Oy
Manufacturer's contact: Kipinätie 1, 06150 PORVOO, FINLAND
tel +358 (0)207 528 800, fax +358 (0)207 528 844
enervent@enervent.fi, www.enervent.fi

Description of the product: Ventilation unit with heat recovery

Trade name of the product: Enervent® greenair Plaza eco EC(E)
Enervent® greenair Pingvin (eco) EC(E)
Enervent® greenair Pingvin eco XL EC(E)
Enervent® greenair Pandion (eco) EC(E)
Enervent® greenair Pelican (eco) EC(E)
Enervent® greenair Pegasos (eco) EC(E)
Enervent® greenair Pegasos (eco) XL EC(E)
Enervent® greenair LTR-3 (eco) EC(E)
Enervent® greenair LTR-6 (eco) EC(E)
Enervent® greenair LTR-7 (eco) EC(E)
Enervent® greenair LTR-7 (eco) XL-EC(E)

Representatives for the products in the region of EU:

Sweden: Ventener, Örelidsvägen 10, 517 71 OLSFORS, SVERIGE, phone: +46 735-62 00 62
Climatprodukter AB, Box 366, 184 24 ÅKERSBERGA, SVERIGE, phone: +46 8 540 87515
DeliVent Ab, Markvägen 6, 43091 HÖNÖ, SVERIGE, phone: +46 70 204 0809

Estonia: As Comfort Ae, Jaama 1, 72712 PAIDE, EESTI, phone: +372 38 49 430

Ireland: Entropic Ltd., Unit 3, Block F, Maynooth Business Campus, Maynooth, Co. Kildare, IRELAND
phone: +353 1 6106170

Germany: Aircom - innovative Lüftungsanlagen Berlin GmbH, Mittelstraße 5, 13586 BERLIN, GERMANY
phone: +49 30 93661198
e4 energietechnik GmbH, Burgunderweg 2, 79232 MARCH, GERMANY, phone: +49 7665 947 25 33

Austria: Inocal Wärmetechnik Gessellschaft m.b.H, Friedhofstrasse 4, 4020 LINZ, AUSTRIA,
phone: +43 732 65 03 910
M-Tec Mittermayr GmbH, 4122 ARNREIT, AUSTRIA, phone: +43 7282 7009-0

Poland: Iglotech, ul. Toruńska 41, 82-500 KWIDZYN, POLAND, phone: +48 (55) 645 73 20

The products are in conformity with the following standards:

LVD EN 60 335-1 (2002) +A1 (2004), +A2 (2006), +A11 (2004), +A12 (2006)
MD EN 292-1 (1991), EN 292-2 (1991) +A1 (1995)
EMC EN 55014-1 (2006), EN 61 000-3-2 (2006) and EN 61 000-3-3 (1995).
EN 55014-2 (1997)+A1 (2002).

The conformity of each manufactured product is taken care according our ISO 9001 quality descriptions.

Porvoo 3.1.2009

Enervent Oy

Tom Palmgren
Technology Manager

I WARRANTY CONDITIONS 04/2010

1. Enervent Oy grants a warranty on products (hereinafter "equipment") manufactured and marketed by the company.
2. These warranty conditions define the applicable warranty liability and liability restrictions in detail.
3. Enervent Oy warrants that, when properly installed and used normally and in accordance with the instructions for use as well as the applicable regulations, the equipment will work flawlessly and also be free of raw material defects.
4. The warranty period starts on the date of purchase as indicated on the purchase receipt.
5. The warranty period is 2 years from the date of purchase but no longer than 3 years from the date of manufacture. Warranty repairs do not affect the warranty period.
6. If defects occur, the customer is to report these defects without delay to the local Enervent Dealer or the Enervent Importer or to the manufacturer Enervent Oy. If a defect causes damage or injuries or presents a risk of damage or injuries, it must be reported immediately. The report must specify the type of defect, the location of the equipment, the installer and seller of the equipment as well as the contact information of the person submitting the report.

II WARRANTY REPAIRS

1. Warranty repairs may only be performed by Enervent Oy or by contractors with the appropriate installation rights.
2. Warranty repair means repair and replacement work under a warranty, irrespective of the number of replaced parts.
3. Performing a warranty repair requires that the person performing the repair is presented with:
 - a. The receipt of purchase of the equipment, including equipment identification information, the date of purchase of the equipment and the seller of the equipment; and
 - b. The installation certificate completed and signed by the installer.
4. The equipment is to be delivered to the person performing the warranty repair, or, when the equipment installation is permanent, the person performing the warranty repairs to be provided with sufficient time and the necessary indoor space for performing the repair. Any furniture and other objects that may hinder the repair work must be removed in advance.
5. The obligation to perform a warranty repair and the warranty will expire if:
 - a. The rating plate of the equipment has been modified or removed;
 - b. The receipt of purchase and/or installation certificate of the equipment has not been presented;
 - c. The installation was performed by a party other than Enervent Oy or a contractor with the

- appropriate installation rights;
- d. The equipment has been repaired by a party other than Enervent Oy or a contractor with the appropriate installation rights;
- e. The equipment has been installed or repaired in such a way that the work cannot be considered to have been performed in a professional and competent manner;
- f. The equipment has been mechanically damaged or subjected to corrosion; or
- g. The equipment has not been used normally and in accordance with the instructions for use and the effective regulations.

III EXCEPTIONS

1. This warranty does not cover:
 - a. Defects due to improper installation of the equipment, abnormal use or use contrary to the instructions for use and the effective regulations;
 - b. Defects due to neglected maintenance or improper storage of the equipment;
 - c. Equipment damage caused by the user;
 - d. Defects caused by a lightning strike or voltage fluctuations or any other unavoidable factor;
 - e. Defects caused by repair or maintenance of the equipment when performed by a party other than Enervent Oy or a contractor with the appropriate installation rights;
 - f. Change or replacement of parts subject to wear and tear during normal equipment use, such as light bulbs, LEDs, fuses, etc.;
 - g. Equipment with modified or removed rating plate;
 - h. Equipment for which a receipt of purchase or an installation certificate (for equipment that is not self-installed) has not been presented; or
 - i. Consequential damage caused by the device or due to warranty repairs or damage or loss arising from disconnecting, sending or re-installing the equipment.

IV RESTRICTION OF LIABILITY

Enervent Oy shall not be liable for any consequential damage possibly caused by the equipment, such as interruption of production or lost turnover, loss of profits, disruption to the living environment or any corresponding circumstances, unless due to gross negligence or where otherwise agreed case-by-case regarding the conditions for consequential damage. Furthermore, Enervent Oy shall not be liable for delays due to causes beyond Enervent Oy's reasonable control.



VENTILATION UNIT MAINTENANCE

The ventilation unit does not require any mechanical maintenance, only changing of the filters periodically and cleaning of the heat exchanger and fans (when needed). Cut the power supply to the unit before starting any service work (from the main switch or by removing the service hatch of the LTR-series units). Wait for two (2) minutes before starting the maintenance work! Although the unit's power supply is cut when the hatch is opened, the fans still rotate and the electrical coil in EC-model is still hot for a while.

CLEANING THE HEAT EXCHANGER

When changing the filters, check if the heat exchanger is dirty. If cleaning is required, remove it from the unit and carefully wash through the air channels with a hand shower using a mild detergent, taking care not to get the motor wet. The heat exchanger can also be cleaned by blowing through the air channels using compressed air. Do not use a pressure washer and do not submerge the heat exchanger into water!! When restarting the unit after cleaning, check that the heat exchanger wheel can turn freely.

CLEANING THE FANS

When changing filters, also check the condition of the fans. If cleaning is required the fans can be removed from the unit and cleaned with a toothbrush or compressed air.

CHANGING OF FILTERS

The recommended time between filters changes is max. four (4) months for plain filters and max. six (6) months for bag filters. If class EU5 bagfilters are used the time between filter changes can be prolonged to one (1) year, by vacuuming the filters on the inside. Changing plain filters; Remove the filter cassettes from the device and loosen the filter fabric from the frame. Replace new filter fabric back into the frame. Replace the filter cassette back into the unit so that the support mesh faces towards the heat exchanger. Changing bag filters; Open the lock and remove the old filter and put in a new one. Remember to lock it afterwards.

Vacuum cleaning the inside of the device is recommended at this point. NB! Make sure to close the service hatch carefully!

Ventilation units and filters

UNIT	STANDARD FILTERS	CHANGE RATE	ALTERNATIVE FILTERS	CHANGE RATE
Plaza	F7 cassette filter/ F5 bag filter	6 months	-	
Pingvin	F5 plane filter / F5 plane filter	4 months	F7 cassette filter in the supply air in addition to the F5 plane filter	6 months
Pandion	F5 bag filter / F5 bag filter	6/12* months	F7 bag filter in supply or/and exhaust air	6 months
Pelican	F5 bag filter / F5 bag filter	6/12* months	F7 bag filter in supply or/and exhaust air	6 months
Pegasos	F5 bag filter / F5 bag filter	6 months	F7 bag filter in supply or/and exhaust air	6 months
LTR-3	F5 plane filter / F5 plane filter	4 months	F5 or F7 bag filter in supply or/and exhaust air	6/12* months
LTR-6	F5 bag filter / F5 bag filter	6/12* months	F7 bag filter in supply or/and exhaust air	6 months
LTR-7	F5 bag filter / F5 bag filter	6/12* months	F7 bag filter in supply or/and exhaust air	6 months

*The utilization time can be prolonged by vacuuming the filter bags on the inside. NOTE! The F7 filters break if they are vacuumed.

You can buy filters as well as other equipment for your Enervent ventilation unit from your local Enervent dealer. Please remember to check what model your ventilation unit is before you order equipment.



QUICK GUIDE TO THE VENTILATION UNIT

GENERAL INFORMATION ABOUT VENTILATION

The basic function of the ventilation unit is to maintain good indoor air quality. When the ventilation is planned the engineer calculates how big the air amounts need to be in order to get sufficient ventilation. The installer specifies the normal fan speed for the unit when he installs the unit and calibrates the air flows at every terminal.



USING THE VENTILATION UNIT

It is very simple to use the ventilation unit. Most of the time it needs no attention. The most important functions are:



Fan speed



The symbols are found on the control panel.

There are four fan speeds to choose from on the control panel. Simplified three of these speeds are used; **normal speed**, which is specified by the installer and on which the unit runs most of the time; **boosting speed**, which is bigger than the normal speed and is used for temporary airing and **away speed**, which is used when nobody is at home. NEVER TURN OFF THE VENTILATION UNIT!
 THE NORMAL SPEED, SPECIFIED BY THE VENTILATION INSTALLER, IS _____ FOR THIS UNIT.

The temperature of the supply air blown into the rooms can be chosen from four steps on the control panel. The after heater is on if any of the four LED lights indicating after heating is lit. NOTE! Not every unit is equipped with after heating.

After heating



Heat recovery



The is an on/off switch for the heat recovery on the control panel. If the LED light is lit, the heat recovery is on. Heat is recovered from the exhaust air when the heat recovery is on. It is consequently sensible to keep the heat recovery on almost always. It is possible to turn off the heat recovery, i.e. in summer time when it is warm outside. It is sensible to turn off the heat recovery at night in summer time to let the cool night air flow inside. When the heat recovery is turn on for the day it works as cooling recovery. The red service LED light is on when it reminds of filter changes and flashes when it indicates a problem. See Service / Alarm indication on page 12.

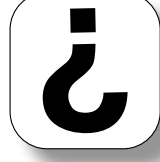

VENTILATION DICTIONARY

Outside air
 The fresh air flow from the outside to the ventilation unit is called outside air.
 Supply air
 The air flow from the ventilation unit to the rooms is called supply air.
 Exhaust air
 The air flow from the ventilation unit is called waste air.
 Jättilma
 The heat exchanger is a component of the ventilation unit that carries heat energy from the exhaust air flow to the supply air flow. Event ventilation units are equipped with a rotating heat exchanger. The rotating heat exchanger is a wheel made of thin metal foil, which stores the heat from the exhaust air and carries it to the supply air. The heat exchanger prevents the warmth from the rooms from escaping with the waste air flow.
 After heating
 The after heating heats the supply air before it is blown into the rooms. In ECC-units the after heating is realized with an electrical heater. All units are not equipped with after heating.
 ECC
 ECC is the ventilation unit's control. ECC is an abbreviation of Electronic Climate Control.

